

Full HD
1080P

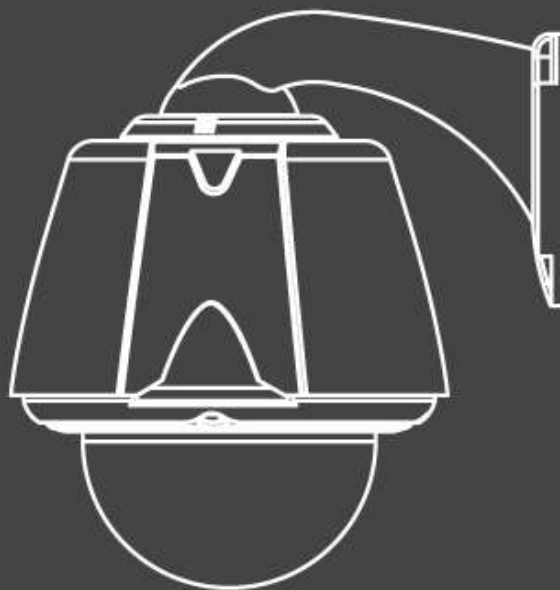

2Megapixel **TVI & AHD** *Hybrid* Speed Dome Camera
User manual

Version F0806

Content

1. Caution.....	3
2. Product Introduction	5
2.1. Description and features.....	5
2.2. Product package	6
2.3. Name and function of each part	7
2.4. Installation.....	9
3. DIP switch setting.....	15
3.1. DIP Switch setting	15
3.2. Protocol setting.....	16
3.3. Address DIP Switch Setting	17
3.4. OSD Menu setting	18
3.4.1. OSD Menu control.....	18
3.4.2. Menu function	19
3.4.3. Set-up menu, Execute and delete by keyboard.....	39
3.4.4. OSD Message Description	43
4. TROUBLE SHOOTING.....	45
5. Dimension.....	46
6. Configuration diagram.....	47
7. Specification	48

1. Caution

Thank you for purchasing our product. Please operate the product after being fully aware of the manual. Please contact us if you have any query.

Precaution

Note the following matters before the installation of the product.

Avoid the following places for the installation.

A high/low temperature: Using indoor-cameras in the places of $+50^{\circ}\text{C}$ ~ -10°C can cause troubles and lower its capacity.



Snow, rain and wet: Humidity or water and any liquid inside-camera can cause troubles.



Oil, gas: Oil and gas can damage the camera as they go through the cameras.



Vibration, shock: They bring on problems or errors of the camera.



Direct light, exposure to the air: In the case of that sets indoor- cameras outside where the weather is changeable, it can cause problems.



Closing to High frequency and electric power lines: Setting the camera up around electromagnetic units or power supplier can cause problems.



Caution in Use

Do not disassemble the unit and put alien substances in the unit.

Disassembling the unit or putting alien substances such as a metal can make the camera defective.

- Make sure of power switch-off before the installation.
- : Ensure power switch-off and check the voltage the camera before the installation.
- Do not give the unit a shock and an operation.
- : Giving a strong shock or an excessive power on the button, terminal can cause problem.



This product has been designed and manufactured in accordance with the harmonized European standards, following the provisions of the below stated directives.

Electromagnetic Compatibility Directive 89/336/EEC(EN61000-3-2:1995, EN61000-3-3:1995, EN50081-1:1992, EN50082-1:1997)

This device complies with part 15 of the fcc rules operation is subject to the following two conditions: (1) This device may not cause harmful interference and (2) This device must accept any interference received including interference that may cause undesired operation

Caution :

- ① Must use AC24V power source, current intensity must be less than 2A and must use a double winding transformer
- ② Never extend the power line from adaptor to camera.
- ③ Please use more thick cable than 18AWG(1.0mm), if you want to extend the power line.
- ④ You must use one adaptor per one camera that is being provided.
- ⑤ Use extra power supplier, If you want to supply many piece of cameras.

2. Product Introduction

2.1. Description and features

This camera, 2 Megapixel Full HD TVI/AHD Hybrid speed dome camera, has been designed elegantly for buildings, department stores that need to be in harmony with the interior as a high speed dome camera, including various observation functions.







- Feature -

- Support full 2.2 Megapixel Full HD-SDI (1080p)
- Optical x20 zoom rates, Digital x16 zoom rates
- Enhance Electronic sensitivity lowest illumination 0.0005Lux (DSS Control)
- Change to B/W model (0.1Lux) at night by ICR DAY & Night
- Digital Noise Reduction (DNR), True WDR and Defog Functions
- Motion detection, Privacy zones.
- Various surveillance functions
Preset(250), Group(12), Tour, Trace, Spiral
- Remove moisture inside of camera by using fan & heater
- Automatic movement detecting area as Alarm receiver unit or Sensor
- RS422/485 remote control
- Built-in Auto Tilt (Automatic 180° tilt rotation)
- Available to public office, indoor or outdoor, Parking violation

2.2. Product package

The following items are included in the product package.

MEGA Speed Dome Camera	1 pcs	
Wall Mount Bracket	1 pcs	
Power Supply (Power Cable & Linear AC24V/2.5A adapter)	1 pcs	
Bracket Blank Rubber	2 pcs	

2.3.Name and function of each part

- Exterior -

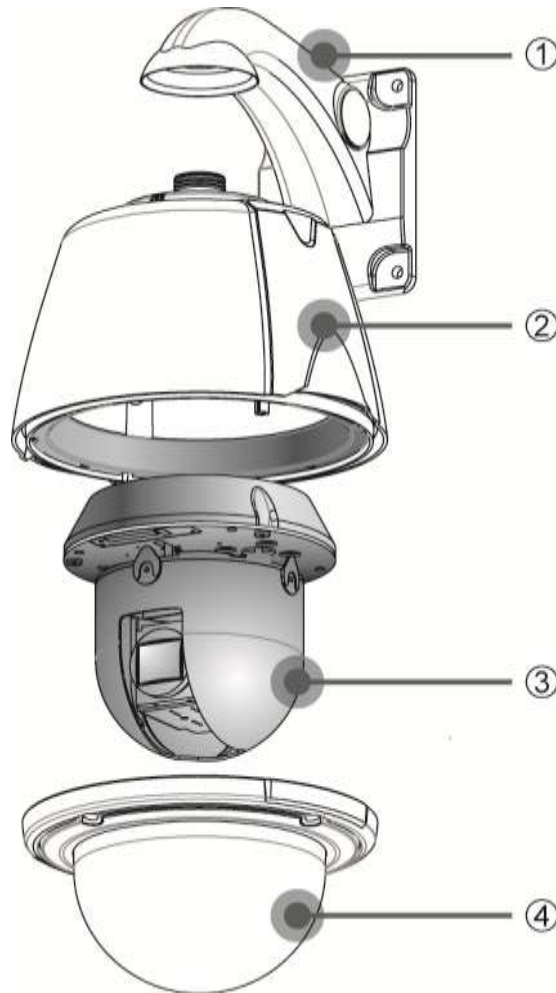

No	Name	Function
①	Wall Mount Bracket	Attached wall bracket on the wall
②	Camera Housing	Outdoor PTZ housing. - when the product is released, outdoor housing and indoor housing are united, when the user installs the camera in indoor and in-ceiling, only use indoor housing taking apart from outdoor housing.
③	PTZ Camera	PTZ dome drive (Pan/Tilt/Zoom)
④	Dome Clear Bubble	Protect Lens and PTZ dome drive

- Connect Cover Inside -

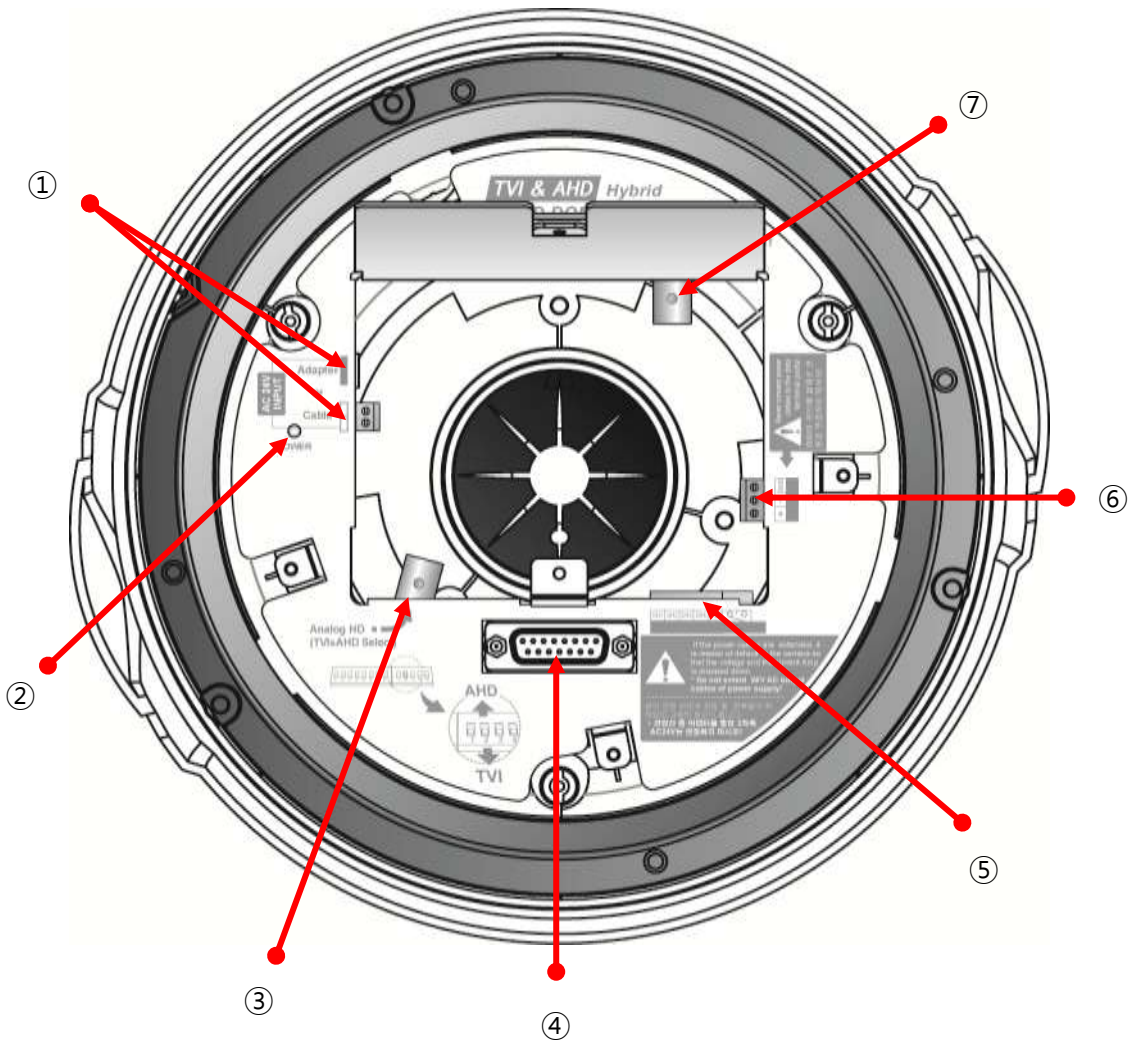

No	Name	Function
①	Power Port	AC 24V / 2.5A Power input
②	Power LED	Turn on the light when its power on
③	HD Video Output Port	You can change mode to TVI or AHD as DIP S/W
④	15 Pin D-SUB Port(Female)	PTZ camera connector
⑤	ALARM In/output port	ALARM in/output (4 In / 1 Out)port
⑥	Communication port	RS-485 PTZ control communication port
⑦	External video output port	CVBS Video output, Camera Control's Power Frequency is set automatically installation country's video output Hertz, 50Hz – PAL / 60Hz – NTSC. It doesn't display Camera OSD and icon

2.4. Installation

1. Installing wall mount bracket

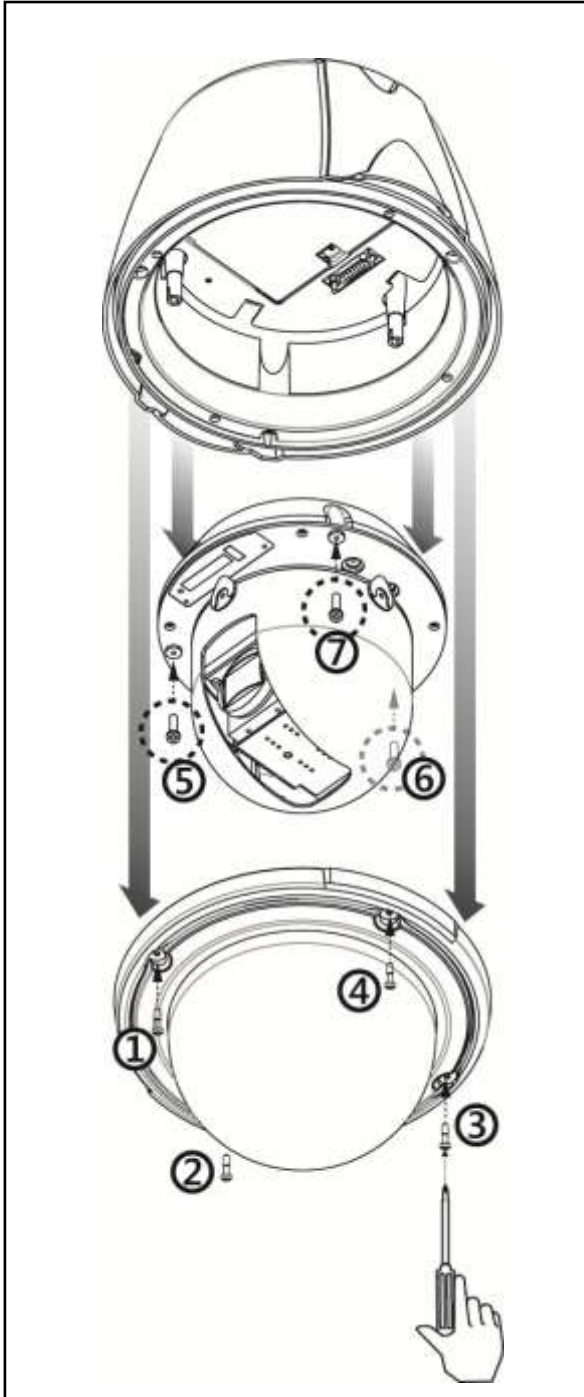

- ① Loosen 4 bolts of cover and 3 bolts of camera body from camera housing (Not loosen the bolts completely)

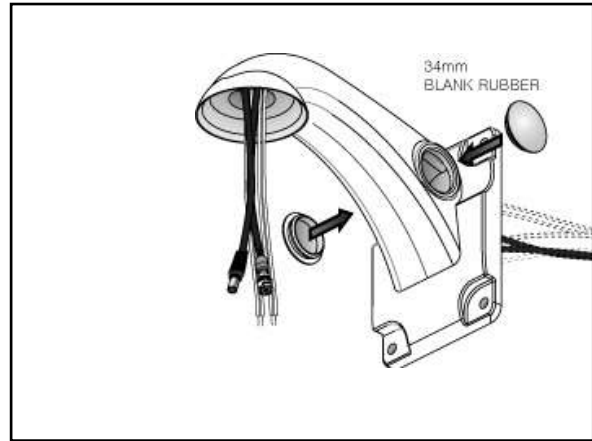

- ②-1. Put cables (Power, Video, data) in the bracket and fasten bracket on the wall by 4 bolts then close both holes provided 34mm Blank rubber

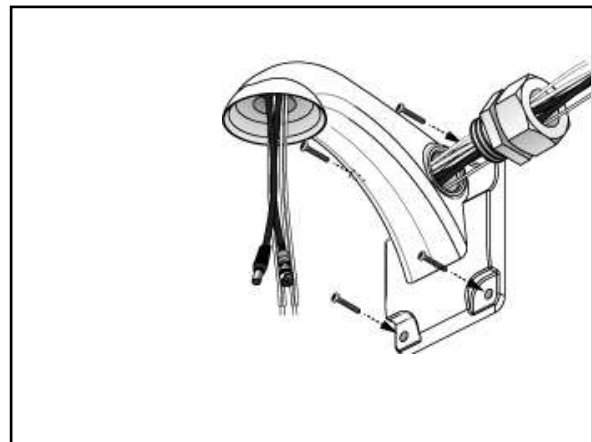

- ②-2. When the camera is installed retaining wall or Concrete building, put the cables in the bracket as picture and close hole by TAB/P1/11 flexible connector(28")

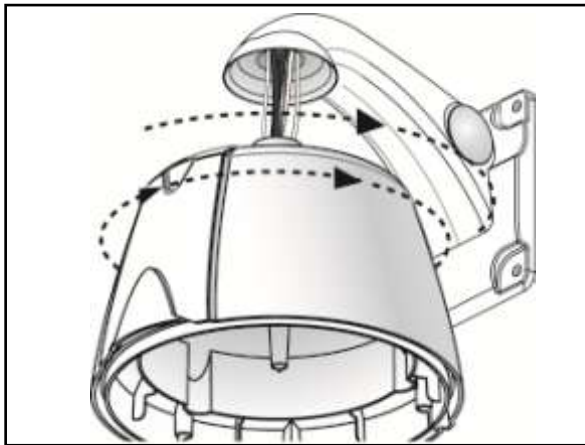

③ Connect Cover housing to wall bracket as above.



④ Open housing connecting cover and connect Power, data, video cables



⑤ Connect to Clear bubble

2. Installing Ceiling Mount Bracket

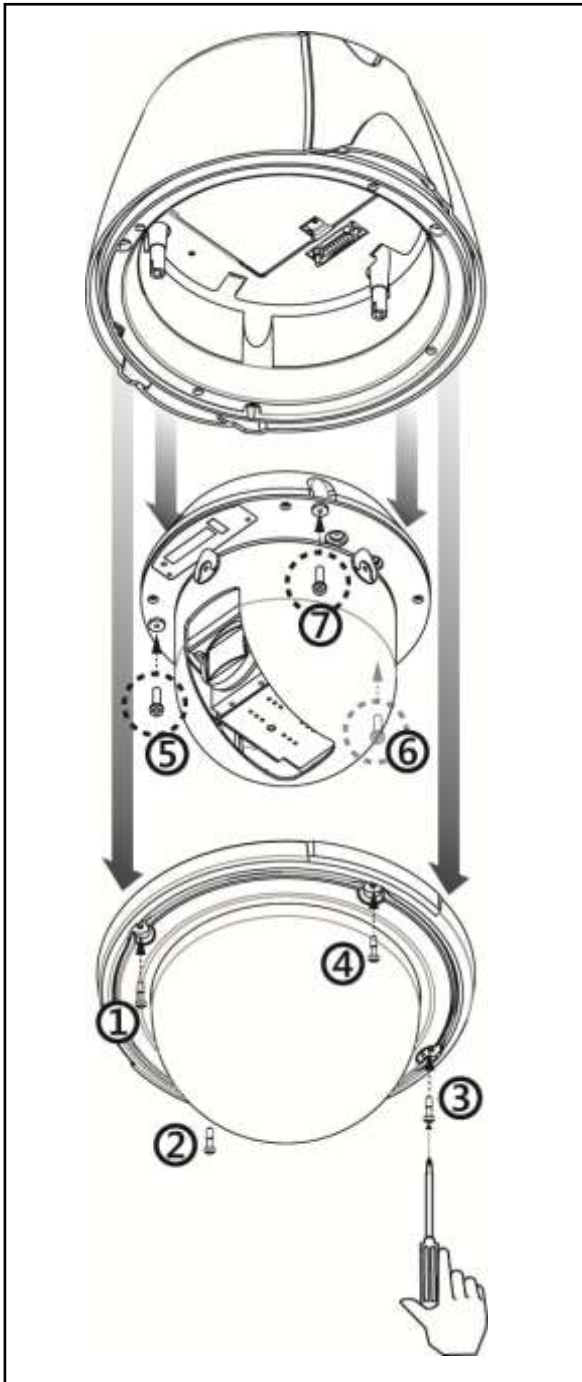

① Loosen 4 bolts of cover and 3 bolts of camera body from camera housing (Not loosen the bubble cover bolts completely)

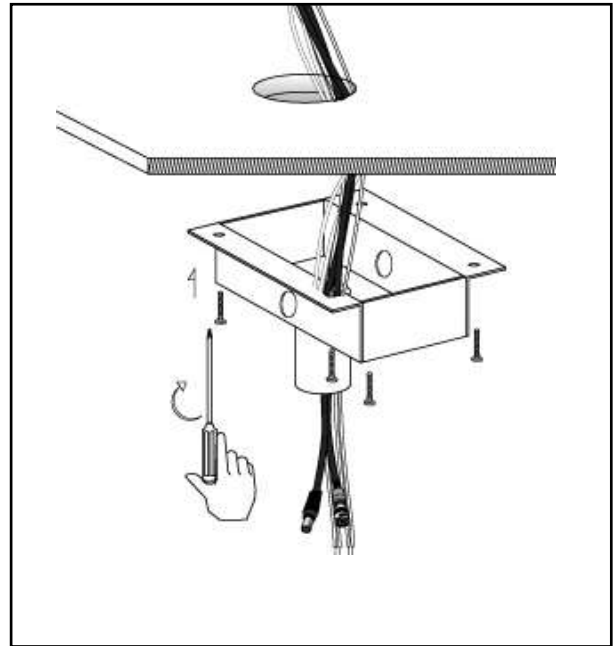

② Attach Pole box on the ceiling

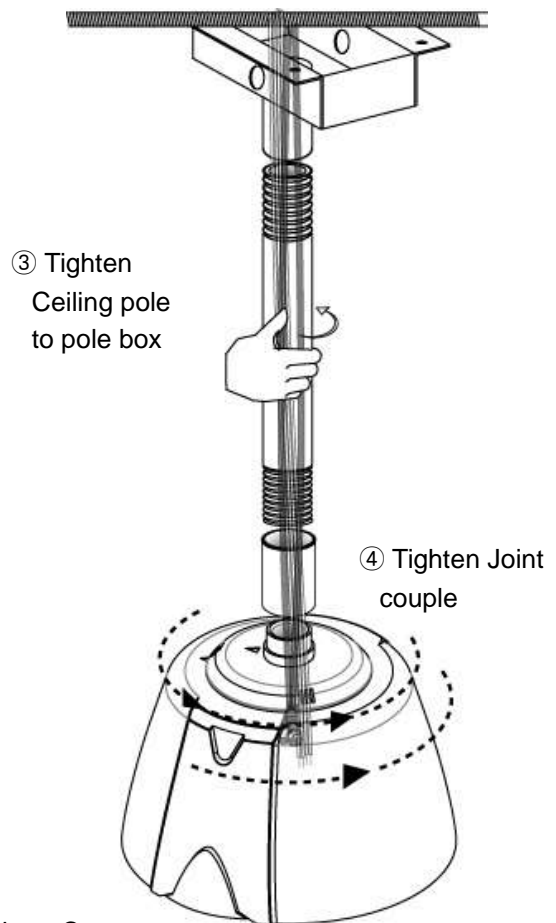

③ Tighten Ceiling pole to pole box

④ Tighten Joint couple

⑤ Tighten Cover housing



⑥ Connect to Data, Video and Power

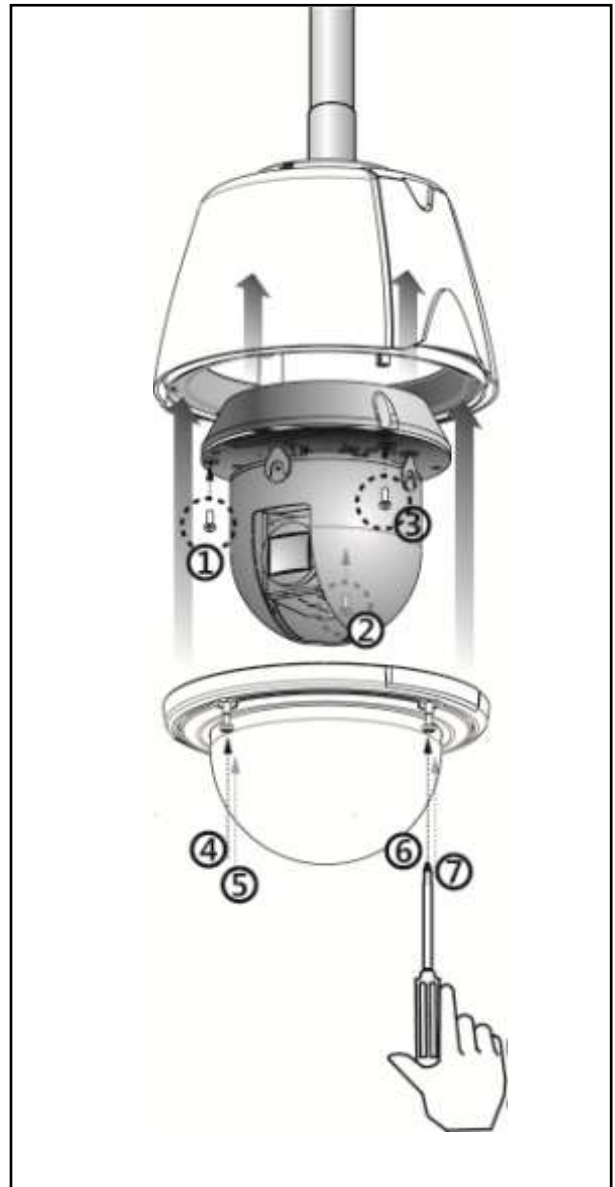

⑦ Connect to the clear bubble

3. Using Speed Dome Junction Box

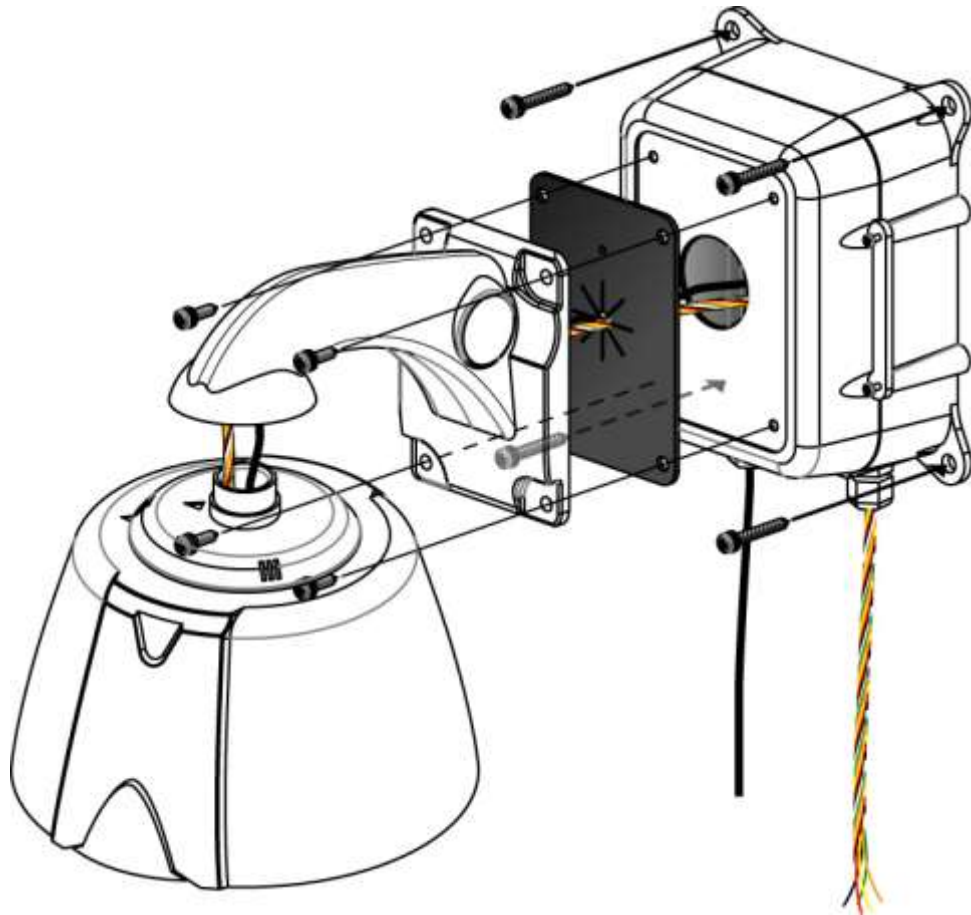

- Speed dome junction box installation -

Fasten screw up 4 screws of the junction box in order of Camera housing → Wall mount bracket → Water-proof cover → Speed dome junction box → Wall

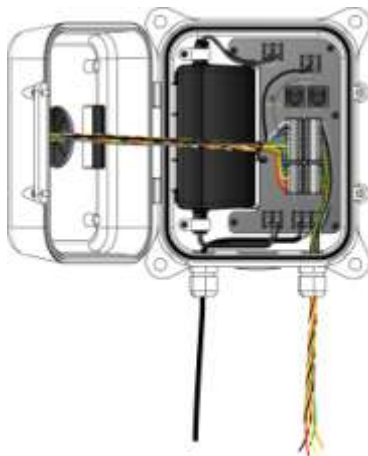

Junction box connection



Camera connection

For connecting cables in the junction box, Please refer to wall mount bracket installation part The PTZ junction box inside part is as below.

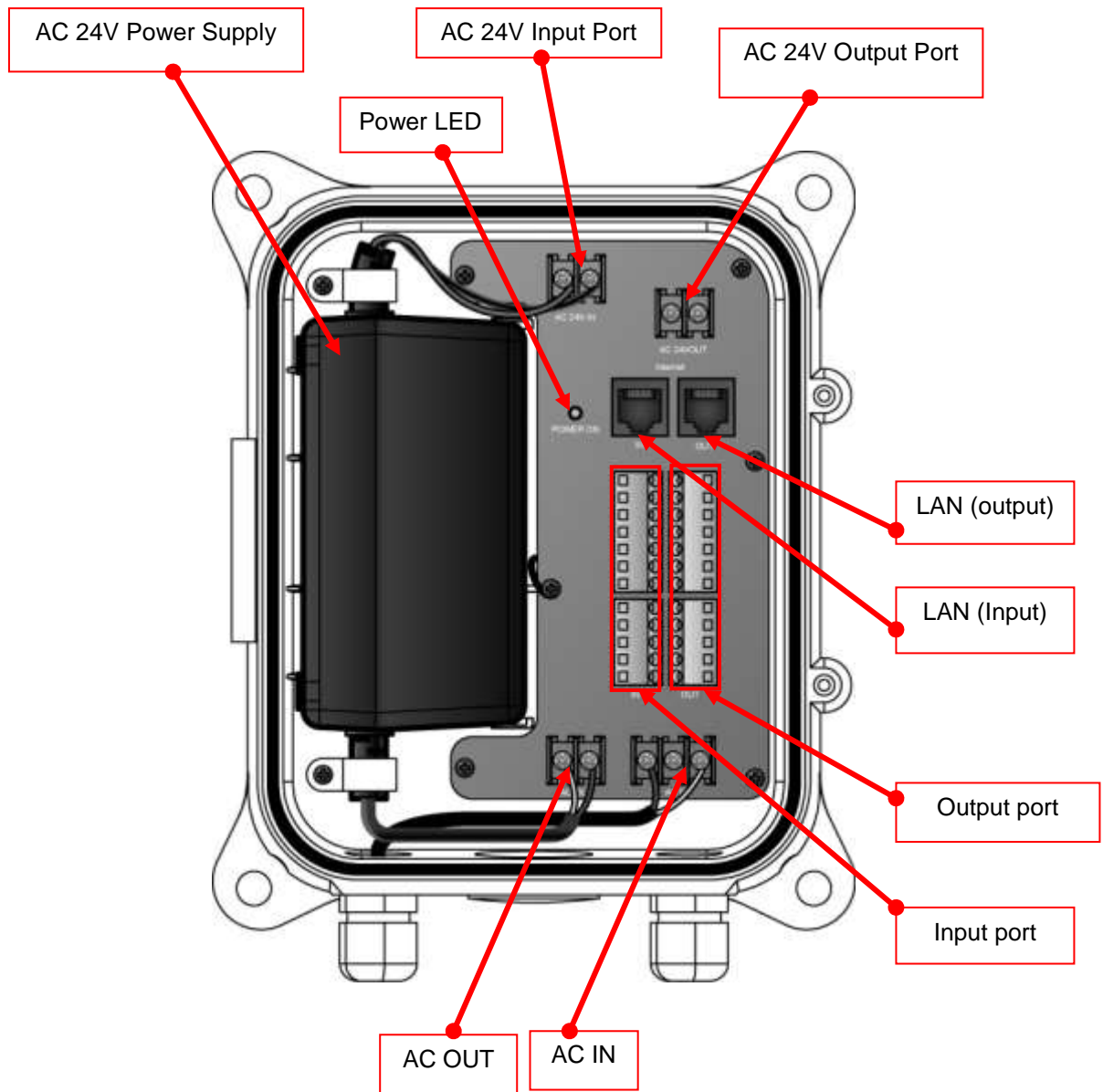

※ Please refer to the speed dome junction box user manual.

3. DIP switch setting

3.1. DIP Switch setting

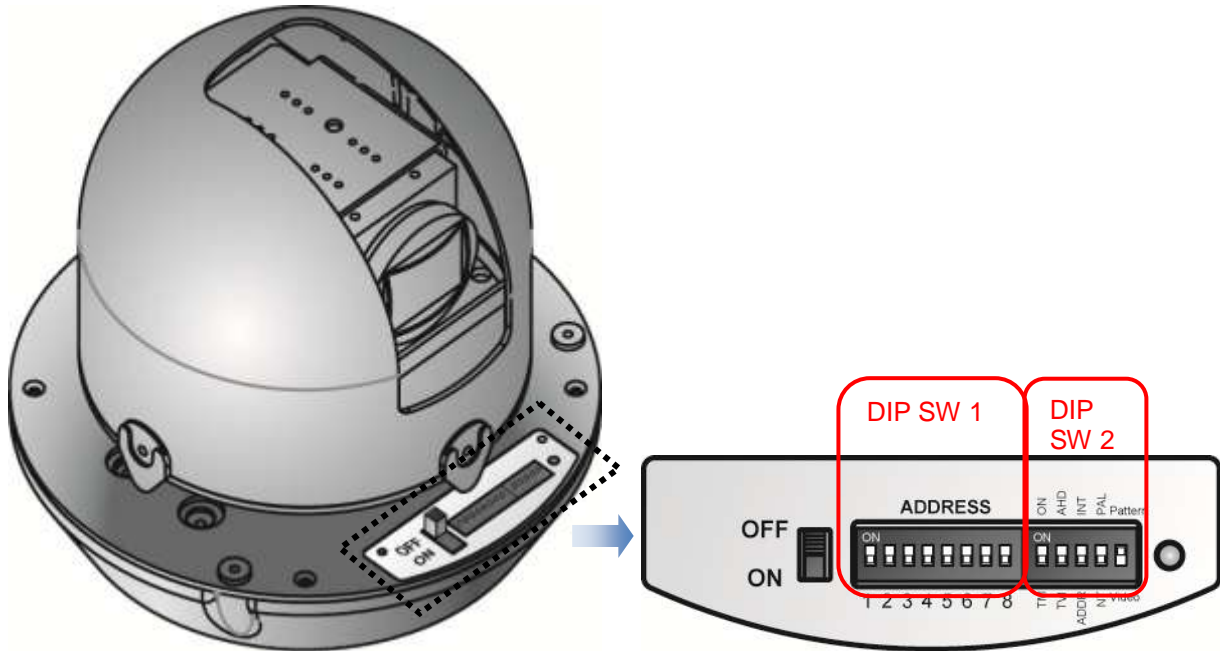

DIP SW 1

You can set communication speed, protocol and number of the camera

DIP SW 2

-Termination Resistor (DIP S2/SW1):

Turn the last camera on the data line as a switch to turn on/off the terminal resistor on.

Turn the DIP SW of some of the farthest cameras on in the case of the data lines distributed to several directions.

(** The default is off. **)

- TVI / AHD SELECT (DIP S2/SW2) :

Select video output mode to TVI or AHD

-Address / Initial Select (DIP S2/SW3):

Set ADDRESS DIP SW in the status of ADDRESS (*Reference to next page*)

Set the communication speed (baud rates) and Protocol (Demand for the technical inquiry) up in the state of the INITAIL.

(.*** The first default is ADDRESS.**)

- PAL / NTSC (DIP S2/SW 4) :

Select PAL / NTSC system

- Video / Pattern (DIP S2/SW 5) :

It will be display color pattern in pattern mode.

3.2. Protocol setting

Set up the switch

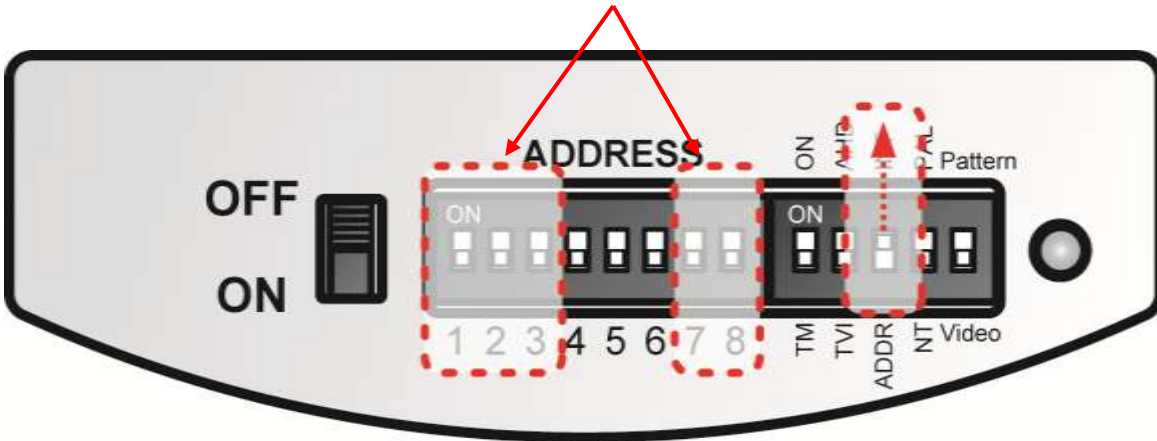

The switch for select protocol

The switch for select baud rates

PROTOCOL	S1					S2
	SW1	SW2	SW3	SW7	SW8	SW 'INIT↔ADDR'
D-MAX (9600 bps)	OFF	OFF	OFF	OFF	OFF	INIT
P-P (9600 bps)	ON	OFF	OFF	OFF	OFF	INIT
P-P (4800 bps)	ON	OFF	OFF	OFF	ON	INIT
P-P (2400 bps)	ON	OFF	OFF	ON	OFF	INIT
P-D (9600 bps)	OFF	ON	OFF	OFF	OFF	INIT
P-D (4800 bps)	OFF	ON	OFF	OFF	ON	INIT
P-D (2400 bps)	OFF	ON	OFF	ON	OFF	INIT
S-T (9600 bps)	OFF	OFF	ON	OFF	OFF	INIT

Change S2 to INIT if user wants to change protocol

- ① Please the power off
- ② Switch protocol that user wants to change on in the above the table
- ③ The power on, then the set protocol and baud rates are displayed.
- ④ The power off, if every setting is right. Then the change of protocol is finished.
- ⑤ Change No. 3 of S2 to ADDR before the power on, then the power on after setting the address of the camera.
- ⑥ Try it again with the information as above the table, if something is wrong

3.3. Address DIP Switch Setting

ADDRESS is set No 1 ~ 255 by DIP switch 1~8.

RX NO	DIP SWITCH (HEX)							RX NO	DIP SWITCH (HEX)						
	1	2	3	4	5	6	7		1	2	3	4	5	6	7
1	ON	OFF	OFF	OFF	OFF	OFF	OFF	33	ON	OFF	OFF	OFF	OFF	ON	OFF
2	OFF	ON	OFF	OFF	OFF	OFF	OFF	34	OFF	ON	OFF	OFF	OFF	ON	OFF
3	ON	ON	OFF	OFF	OFF	OFF	OFF	35	ON	ON	OFF	OFF	OFF	ON	OFF
4	OFF	OFF	ON	OFF	OFF	OFF	OFF	36	OFF	OFF	ON	OFF	OFF	ON	OFF
5	ON	OFF	ON	OFF	OFF	OFF	OFF	37	ON	OFF	ON	OFF	OFF	ON	OFF
6	OFF	ON	ON	OFF	OFF	OFF	OFF	38	OFF	ON	ON	OFF	OFF	ON	OFF
7	ON	ON	ON	OFF	OFF	OFF	OFF	39	ON	ON	ON	OFF	OFF	ON	OFF
8	OFF	OFF	OFF	ON	OFF	OFF	OFF	40	OFF	OFF	OFF	ON	OFF	ON	OFF
9	ON	OFF	OFF	ON	OFF	OFF	OFF	41	ON	OFF	OFF	ON	OFF	ON	OFF
10	OFF	ON	OFF	ON	OFF	OFF	OFF	42	OFF	ON	OFF	ON	OFF	ON	OFF
11	ON	ON	OFF	ON	OFF	OFF	OFF	43	ON	ON	OFF	ON	OFF	ON	OFF
12	OFF	OFF	ON	ON	OFF	OFF	OFF	44	OFF	OFF	ON	ON	OFF	ON	OFF
13	ON	OFF	ON	ON	OFF	OFF	OFF	45	ON	OFF	ON	ON	OFF	ON	OFF
14	OFF	ON	ON	ON	OFF	OFF	OFF	46	OFF	ON	ON	ON	OFF	ON	OFF
15	ON	ON	ON	ON	OFF	OFF	OFF	47	ON	ON	ON	ON	OFF	ON	OFF
16	OFF	OFF	OFF	OFF	ON	OFF	OFF	48	OFF	OFF	OFF	OFF	ON	ON	OFF
17	ON	OFF	OFF	OFF	ON	OFF	OFF	49	ON	OFF	OFF	OFF	ON	ON	OFF
18	OFF	ON	OFF	OFF	ON	OFF	OFF	50	OFF	ON	OFF	OFF	ON	ON	OFF
19	ON	ON	OFF	OFF	ON	OFF	OFF	51	ON	ON	OFF	OFF	ON	ON	OFF
20	OFF	OFF	ON	OFF	ON	OFF	OFF	52	OFF	OFF	ON	OFF	ON	ON	OFF
21	ON	OFF	ON	OFF	ON	OFF	OFF	53	ON	OFF	ON	OFF	ON	ON	OFF
22	OFF	ON	ON	OFF	ON	OFF	OFF	54	OFF	ON	ON	OFF	ON	ON	OFF
23	ON	ON	ON	OFF	ON	OFF	OFF	55	ON	ON	ON	OFF	ON	ON	OFF
24	OFF	OFF	OFF	ON	ON	OFF	OFF	56	OFF	OFF	OFF	ON	ON	ON	OFF
25	ON	OFF	OFF	ON	ON	OFF	OFF	57	ON	OFF	OFF	ON	ON	ON	OFF
26	OFF	ON	OFF	ON	ON	OFF	OFF	58	OFF	ON	OFF	ON	ON	ON	OFF
27	ON	ON	OFF	ON	ON	OFF	OFF	59	ON	ON	OFF	ON	ON	ON	OFF
28	OFF	OFF	ON	ON	ON	OFF	OFF	60	OFF	OFF	ON	ON	ON	ON	OFF
29	ON	OFF	ON	ON	ON	OFF	OFF	61	ON	OFF	ON	ON	ON	ON	OFF
30	OFF	ON	ON	ON	ON	OFF	OFF	62	OFF	ON	ON	ON	ON	ON	OFF
31	ON	ON	ON	ON	ON	OFF	OFF	63	ON	ON	ON	ON	ON	ON	OFF
32	OFF	OFF	OFF	OFF	OFF	ON	OFF	64	OFF	OFF	OFF	OFF	OFF	OFF	ON

- ADDRESS Table -

- 7 DIP switched on, it can be set 65 ~ 128 as above.
- 8 DIP switched on, it can be set 129~192 as above.
- 7&8 DIP switched on, it can be set 129~255 as above.

3.4. OSD Menu setting

3.4.1. OSD Menu control

■ OSD (ON SCREEN DISPLAY) menu control

It is the function to call up the Menu of the camera.

- ◆ User can not only set Preset, Group, Tour, Swing, Trace functions of the camera up by the menu, but also set them up by shortening keys.

■ OSD MENU Enter

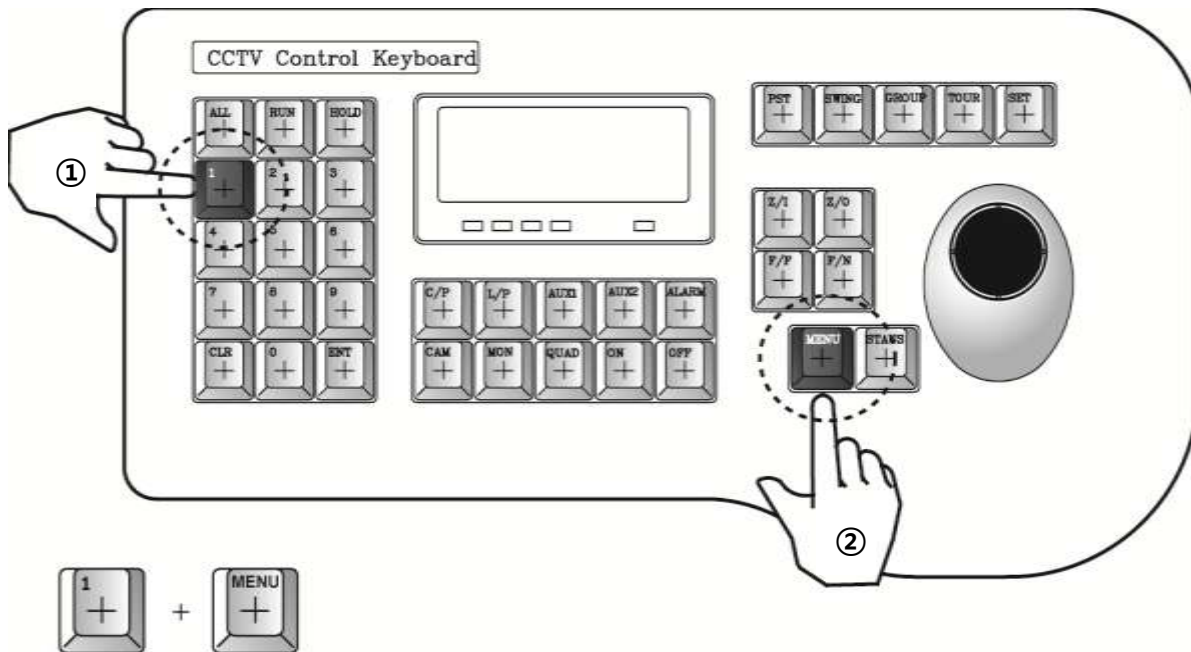

The menu is displayed on the screen with the key tone when user presses No.1 and menu key.

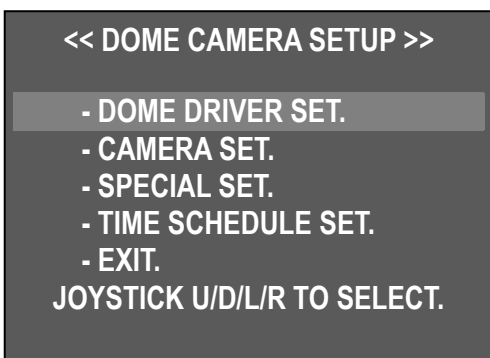

■ OSD Menu Control

- Move cursor by moving joystick up and down.

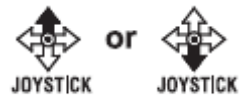

- Select Menu or change to setting and move to Joystick left or right.

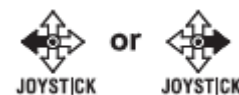

■ Cancellation of OSD menu

- Press No. 1 + Menu button.

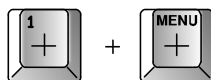

3.4.2. Menu function

■ OSD Menu tree

Main menu	Sub menu 1	Sub menu 2	
DOME DRIVER SET	SET PTZ FUNCTION	SELECT PRESET	
		PRESET ID SET	
		PRESET PTZ SET	
		SWING SET	
		GROUP SET CH:01~12	
		TOUR SET	
		TRACE SET	
DOME DRIVER SET	RUN FUNCTION	n/a	
	SET PRIVACY		
	MANUAL P/T SPEED		
	AUTO TILT MOVE		
	SMART PAN/TILT		
	RETURN TO MAIN PAGE		
CAMERA SET	ID SET	n/a	
	H-V REVERSE		
	AGC CONTROL		
	SHUTTER SPEED		
	SHARPNESS LEVEL		
	BRIGHTNESS LEVEL		
	COLOR LEVEL		
	NEXT MENU PAGE		
	└ DNR LEVEL		
	└ STABILIZER		
	└ FOCUS MODE		
	└ MAX ZOOM LIMIT		
	└ DSS CONTROL		
	└ BACK LIGHT MODE		WDR SET / HLC SET / BLC SET
	└ WHITE BALANCE		n/a
	└ NEXT MENU PAGE		
	└ DAY&NIGHT		
└ DEFOG ON/OFF			
└ DEFOG LEVEL			
└ PREVIOUS MENU PAGE			
RETURN TO MAIN PAGE			
SPECIAL SET	OSD DISPLAY	n/a	
	SELECT ALARM		
	MOTION DETECTION		
	ALARM CHANNEL ON/OFF		
	ALARM PRESET SET		
	AUTO REFRESH TIME		
	NEXT MENU PAGE		
	└ USE SHORTCUT KEY		
	└ RUN DEHUMIDIFICATION		
	└ LANGUAGE		
	└ USE PASSWORD		
	└ CHANGE PASSWORD		
	└ FACTORY RESET !		
└ PREVIOUS PAGE			
RETURN TO MAIN PAGE			
TIME SCHEDULE SET	SCHEDULE FUNCTION SET	n/a	
	SCHEDULE BACKLIGHT SET		
	RESUME TIME SET		
	HOME POSITION SET		
	TIME SET		

	RETURN TO MAIN PAGE	
EXIT	n/a	n/a

- **DOME DRIVER SET.** : Set Pan, Tilt or various surveillance functions.
- **CAMERA SET.** : Set Video, screen display functions.
- **SPECIAL SET.** : Set motion detection, alarm, multi-language, Password, Factory default
- **TIME SCHEDULE SET.** : you can set time schedule for various function in this menu.
- **EXIT.** : Out of OSD menu

■ **DOME DRIVER SET**

1. SET PTZ FUNCTION

Set up or execute Preset, Swing, Group, Tour, Trace.

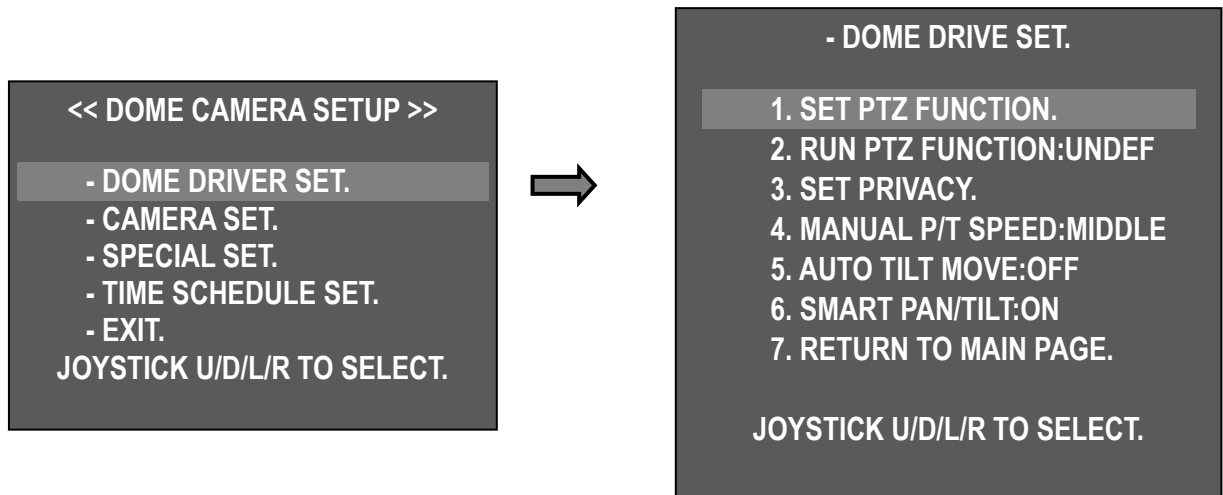

Select "DOME DRIVER SET" in main menu, then move joystick left / right and display sub menu list. Select "1. SET PTZ FUNCTION" then move joystick left/right and display various surveillance function list.

- SET PRESET & RUN.

- 1. SELECT PRESET CH:001
- 2. PRESET ID SET
- 3. PRESET PTZ SET
- 4. SWING SET
- 5. GROUP SET CH:01~12
- 6. TOUR SET
- 7. TRACE SET
- 8. PREVIOUS MENU PAGE.

JOYSTICK U/D/L/R TO SELECT.

1). SELECT PRESET CH

- Set up preset Number.
- Set up preset No by moving Joystick left / right.

◀ : Number up / ▶ : Number down

◆ Set up Max. 250 programmable Preset No.

2). PRESET ID SET

- User can set ID of each preset No.
- Select "2. PRESET ID SET" then moves joystick left or right and displays input of preset ID options.



User can select ID letter or icon by using joystick Up/Down/Right/Left. Shift letter digit by "ZOOM

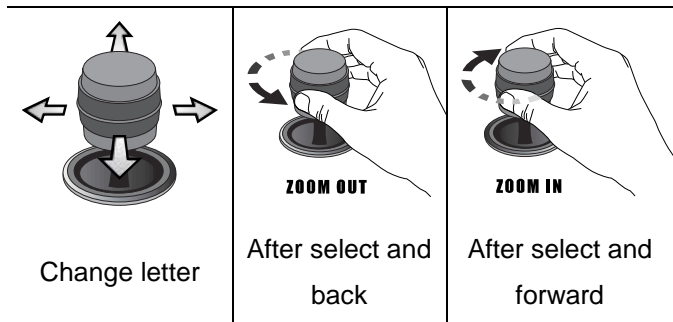

To save designated ID, Please pressing "F/F" key,
No to save ID, Please press "F/N" key, it doesn't save ID and back to previous setting..

3). PRESET PTZ SET

- PRESET setting menu.

"Save "1.SELECT PRESET CH" No and "2. PRESET ID"

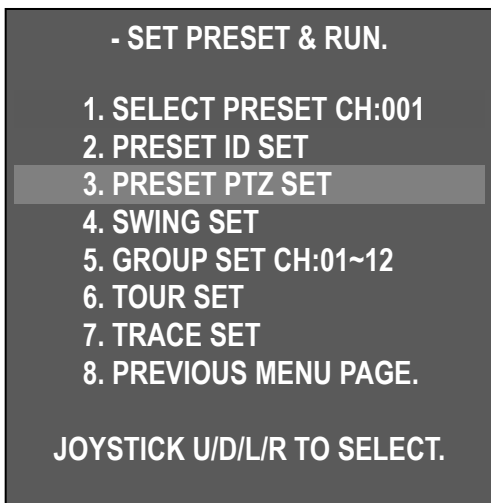

Move to menu as desire by moving joystick up/down/left/right.

Press F/N [SAVE] → [DELETE] → [RETURN], Move cursor and select menu by pressing F/F.

- [SAVE] : Save and go to previous screen
- [DELETE] : Delete PRESET
- [RETURN] : Go to previous screen (Cancellation)

4). SWING SET

- The SWING commands the camera to move between 2 selected positions, monitoring the route

- SET PRESET & RUN.

1. SELECT PRESET CH:001
2. PRESET ID SET
3. PRESET PTZ SET
4. SWING SET
5. GROUP SET CH:01~12
6. TOUR SET
7. TRACE SET
8. PREVIOUS MENU PAGE.

JOYSTICK U/D/L/R TO SELECT.



- SWING SET.

1. PAN/TILT SWING	: UNDEF
2. START PRESET	: 000
3. END PRESET	: 000
4. SWING TIME	: 000
5. SWING SPEED	: 000

F/F SAVE, F/N NOT SAVE.

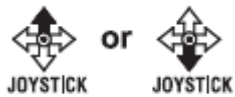

: Moves menu

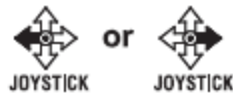

: Changes Setting

1. PAN/TILT SWING	TILT – Move Up and Down. PAN – Move Left and Right.
2. START PRESET	Set start preset point in Swing.
3. END PRESET	Set end preset point in Swing.
4. SWING TIME	Set duration time between Swing movement .(1~127)
5. SWING SPEED	Set movement speed.(1~64)

5). GROUP SET CH: 1~12

User can set up Max. 12 groups and it is included 12 preset points each group. .

- SET PRESET & RUN.

1. SELECT PRESET CH:001
2. PRESET ID SET
3. PRESET PTZ SET
4. SWING SET
5. GROUP SET CH:01~12
6. TOUR SET
7. TRACE SET
8. PREVIOUS MENU PAGE.

SELECT (F/F), CHANGE (L/R)



- GROUP SET CH:001

[P]	[S]	[T]	[P]	[S]	[T]
000	000	000	000	000	000
000	000	000	000	000	000
000	000	000	000	000	000
000	000	000	000	000	000
000	000	000	000	000	000
000	000	000	000	000	000

F/F SAVE, F/N NOT SAVE.

[P]	PESET : Enter PRESET No (Save PRESET No)
[S]	SPEED : Set movement speed (1~64) 1<64
[T]	TIME : Set duration time (1~127 sec)

 JOYSTICK Move next menu	 JOYSTICK Move previous menu	 or  JOYSTICK JOYSTICK Change setting
---	---	---

6). TOUR SET

Tour is included 12 groups.

- SET PRESET & RUN.

1. SELECT PRESET CH:001
2. PRESET ID SET
3. PRESET PTZ SET
4. SWING SET
5. GROUP SET
6. TOUR SET
7. TRACE SET
8. PREVIOUS MENU PAGE.

JOYSTICK U/D/L/R TO SELECT.



- TOUR SET.

T01:00	T02:00	T03:00	T04:00
T05:00	T06:00	T07:00	T08:00
T09:00	T10:00	T11:00	T12:00

F/F SAVE, F/N NOT SAVE.

7). TRACE SET

Save joystick pattern movement for Max. 180 seconds and execute save joystick movement. .

- SET PRESET & RUN.

1. SELECT PRESET CH:001
2. PRESET ID SET
3. PRESET PTZ SET
4. SWING SET
5. GROUP SET
6. TOUR SET
7. TRACE SET
8. PREVIOUS MENU PAGE.

JOYSTICK U/D/L/R TO SELECT.



- TRACE SET.

[SET] [SAVE] [DELETE] [RETURN]
F/F SELECT, F/N SHIFT MENU.

■ TRACE Set

- ① "7. TOUR SET" 
 - ② Press F/N button to select "SET" mode → move camera by using joystick toward position you want up to for 180/sec
 - ③ After finishing all work, move cursor to save mode → press F/N button to save joystick movement
- [SET] : Start TRACE set up
 - [SAVE] : Save and previous OSD screen
 - [DELETE] : Delete TRACE
 - [RETURN] : Go to previous OSD screen (Cancellation)

8). "PREVIOUS MENU PAGE" - It is back to previous menu screen by moving joystick right.



2. RUN PTZ FUNCTION

- DOME DRIVE SET.

1. SET PTZ FUNCTION.
2. RUN PTZ FUNCTION:UNDEF
3. SET PRIVACY.
4. MANUAL P/T SPEED:MIDDLE
5. AUTO TILT MOVE:OFF
6. SMART PAN/TILT:ON
7. RETURN TO MAIN PAGE.

JOYSTICK U/D/L/R TO SELECT.

It is executed various surveillance function by DVR without keyboard.

- "2. RUN PTZ FUNCTION"
- Select desired function, SWING - GROUP - TOUR - TRACE by moving joystick right / left.  or 
- Select desired function and out of OSD menu, it is executed selected function automatically.

Display selected function icon in the screen.



3. SET PRIVACY

Max 8 programmable privacy zones can be configured for the protection of privacy.

- DOME DRIVE SET.

1. SET PTZ FUNCTION.
2. RUN PTZ FUNCTION:UNDEF
3. SET PRIVACY.
4. MANUAL P/T SPEED:MIDDLE
5. AUTO TILT MOVE:OFF
6. SMART PAN/TILT:ON
7. RETURN TO MAIN PAGE.

JOYSTICK U/D/L/R TO SELECT.



- PRIVACY ZONE SET.

CH 01: SET	CH 02: BLANK
CH 03: BLANK	CH 04: BLANK
CH 05: BLANK	CH 06: BLANK
CH 07: BLANK	CH 08: BLANK

PREVIOUS MENU PAGE.

SELECT (F/F), CHANGE (L/R)

■ Setting

- DOME DRIVE SET → SET PRIVACY → Enter PRIVACY ZONE SET Mode

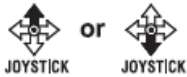

Move Joystick up / down at desired channel then display black box In the middle of screen by pressing “F/F” key.

SET PRIVACY:01
SAVE(F/F), ESC(F/N), MASK(ZOOM)

- Move camera position where you want to hide
- Select privacy zone size by using zoom IN/OUT.

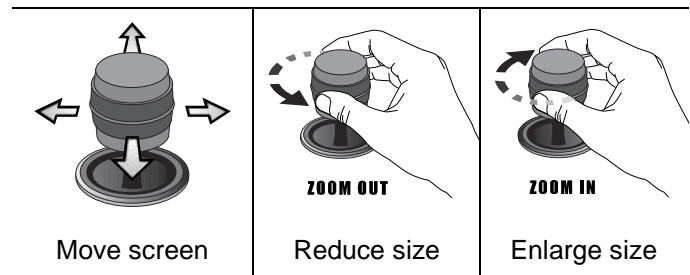

- Set up Privacy zone – adjust box size – Save Privacy setting by “F/F” key then back to previous menu

If press “F/N” key, it doesn’t save privacy zone setting and back to previous screen..

Caution) Not enable to set under 45 degree for PRIVACY ZONE accuracy

- PRIVACY ZONE SET.

CH 01: OFF	CH 02: BLANK
CH 03: BLANK	CH 04: BLANK
CH 05: BLANK	CH 06: BLANK
CH 07: BLANK	CH 08: BLANK

- It is changed SET - ON - OFF – DEL in order each privacy setting channel by moving joystick left / right.

SET	ON	OFF	DEL
Set new privacy area	Display privacy area	Hide privacy area	Remove privacy area

- Select desired mode and execute selected menu by pressing F/F.

4. MANUAL P/T SPEED

User can control the maximum speed in controlling of up and down; The mode is Low, Medium, Max

5. AUTO TILT MOVE

The PAN is turned in a 180° degree arc automatically when the angle of the camera moves down to the maximum degree, therefore, it is possible to track objects continuously



6. SMART PAN/TILT

This function makes the Pan/Tilt speed automatically as zoom magnification.

■ CAMERA SET

1. ID SET

It is set camera ID up to 16 English letters it is enable to select desired letter by joystick zoom and save camera ID by F/F key and out of menu.

- DOME DRIVE SET.

1. SET PTZ FUNCTION.
2. RUN PTZ FUNCTION:UNDEF
3. SET PRIVACY.
4. MANUAL P/T SPEED:MIDDLE
5. AUTO TILT MOVE:OFF
6. SMART PAN/TILT:ON
7. RETURN TO MAIN PAGE.

JOYSTICK U/D/L/R TO SELECT.

<< DOME CAMERA SETUP >>

- DOME DRIVER SET.
- CAMERA SET.
- SPECIAL SET.
- TIME SCHEDULE SET.
- EXIT.

JOYSTICK U/D/L/R TO SELECT.

- CAMERA SET.

1. ID SET(PRESS F/F KEY).
2. H-V REVERSE : NORMAL
3. AGC CONTROL : MAX
4. SHUTTER SPEED : AUTO
5. SHARPNESS LEVEL : 12
6. BRIGHTNESS LEVEL : 50
7. DNR LEVEL : MIDDLE
8. NEXT MENU PAGE.
9. RETURN TO MAIN PAGE.

JOYSTICK U/D/L/R TO SELECT.



SET ID[_ CAM-000]

!"\$%&'()*+,-./01234567
 89:;<=>?@ABCDEFGHIJKLMNO
 PQRSTUVWXYZ[\]^_`abcdefg
 hijklmnopqrstuvwxyz{|}~°C

ZOOM(IN/OUT), ID SHIFT.
 F/F SAVE, F/N NOT SAVE.

2. H-V REVERSE

Set up H-V reverse mode.

- Normal
- H-REV : Flip the picture horizontally on the screen.
- V-REV : Flip the picture vertically on the screen.
- HV-REV : Flip the picture horizontally and vertically on the screen.

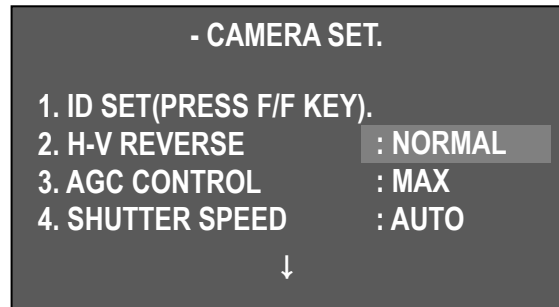

3. AGC CONTROL

AGC(Automatic Gain Control)- It adjusts the amount of video amplification to maintain a full 1-volt peak-to-peak video signal output automatically.

- ▶ OFF, LOW, MIDDLE, MAX

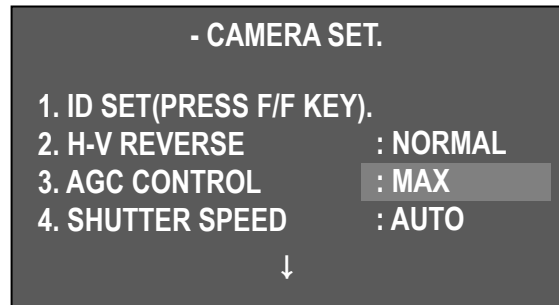

4. SHUTTER SPEED

Adjust camera electronic Shutter speed.

Factory default: Auto.

- ▶ Range : AUTO, A.FLICKER, 1/30 ~ 1/33000

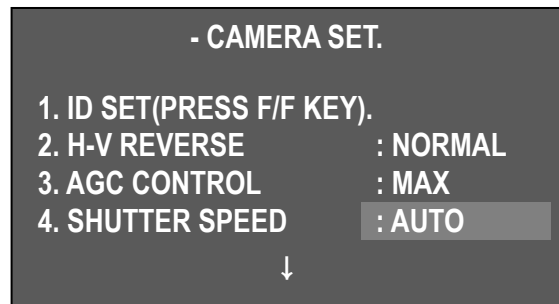

5. SHARPNESS LEVEL

Compensation of the shape of a subject.

- ▶ Range : 1 ~ 31

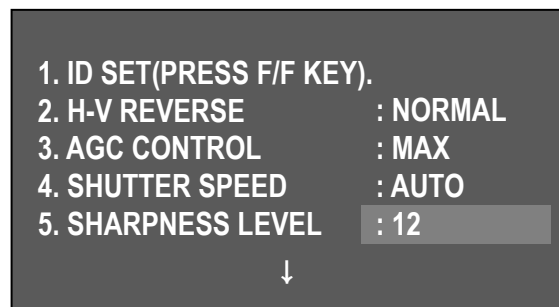

6. BRIGHTNESS LEVEL

Control brightness of a screen.

The screen gets dark because an iris is closed as the numerical value is low, whereas the screen gets bright because an iris is opened as the numerical value is high.

- ▶ Range : 1~99, Default : 50

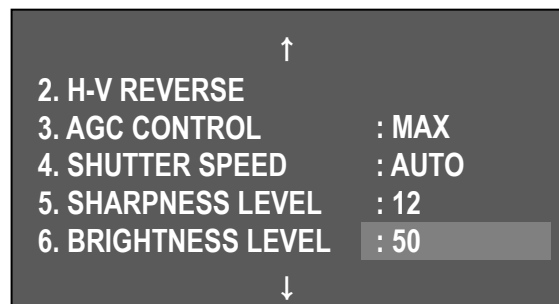

7. COLOR LEVEL

Adjust the color saturation of the image. The higher number denotes a high saturation and low and close to the black-and-white color becomes darker.

- ▶ Range: 1~99, Default: 50

8. NEXT MENU PAGE.

- ▶ Go to next menu page.

9. RETURN TO MAIN PAGE.

- ▶ Go to previous menu.

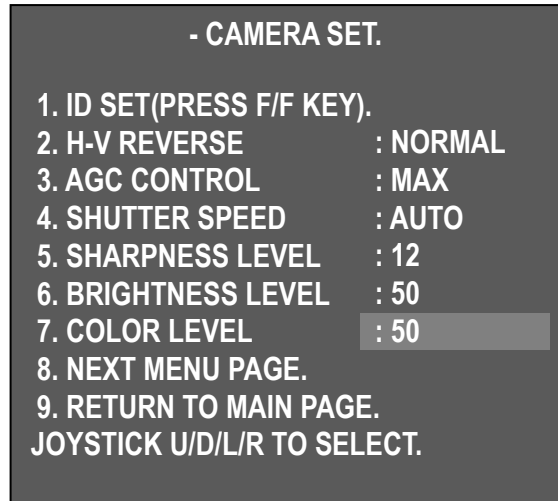

10. DNR LEVEL

Reduce noise of minimum illumination and also file size becomes smaller while DVR is being recorded by the effective reduction of noise.

- ▶ OFF, LOW, MIDDLE, MAX

◆ cf. Not available under AGC off

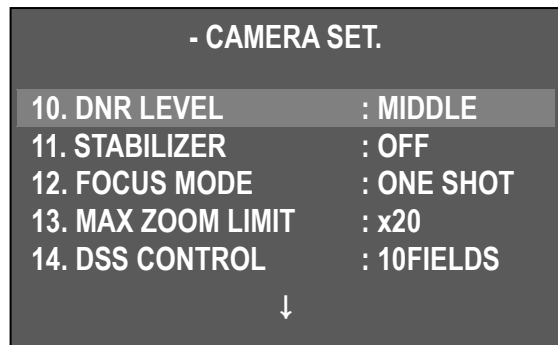

11. STABILIZER

There is some tremble as zoom magnification is high, the function can compensate the tremble.

- ▶ ON / OFF

Select "ON", it is fixed x20 optical zoom magnification in 12.MAX ZOOM LIMIT.(Not available in Digital zoom)

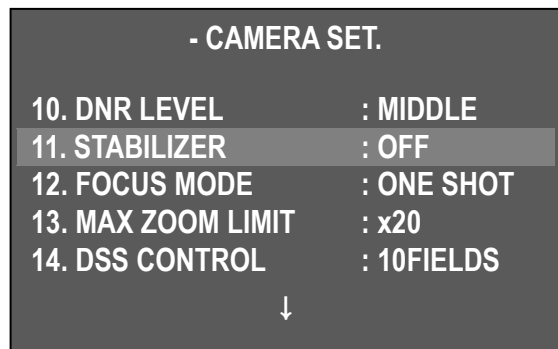

12. FOCUS MODE

Change Focus Mode to hand-worked or auto.

- ▶ MANUAL : User can set focus manually.
- ▶ AUTO : Execute Auto focus as subject movement
- ▶ ONE SHOT : Auto Focusing mode works while zoom is worked

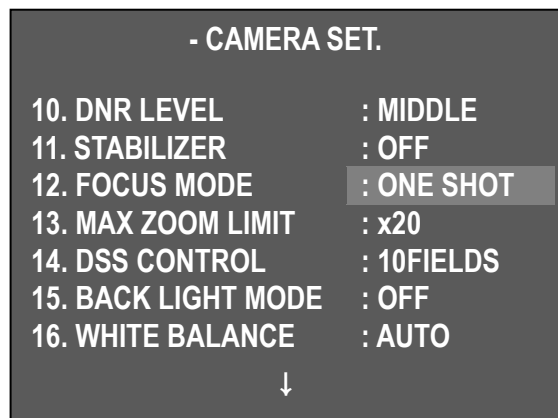

13. MAX ZOOM LIMIT

It is used when user corrects and limits the extensional range of the focus as a function to set the maximum value of zoom. (Available to set DIGITAL ZOOM range)

- ▶ x20(Optical zoom): MAX ZOOM LIMIT OFF status
- ▶ x40~x320(Digital zoom)

14. DSS CONTROL

An object becomes clear as the field value gets higher in Illumination, Max. 60 field, whereas a moving object becomes dim.

- ▶ Range : Off, 2 ~ 60 fields

- CAMERA SET.

10. DNR LEVEL : MIDDLE
 11. STABILIZER : OFF
 12. FOCUS MODE : ONE SHOT
 13. MAX ZOOM LIMIT : x20
 14. DSS CONTROL : 10FIELDS
 15. BACK LIGHT MODE : OFF/WDR/HLC/BLC
 16. WHITE BALANCE : AUTO
 17. NEXT MENU PAGE.
 18. PREVIOUS PAGE
 PRESS F/F SET BACKLIGHT

15. BACK LIGHT MODE

It provides clear images of object and back ground against a severe back light.

- ▶ OFF : Disables the BACKLIGHT
- ▶ WDR : Activates back light. Compensate
- ▶ HLC(High Light Compensation) : Activates High Light back light Compensate
- ▶ BLC : Activates a Use defined back light compensation.

Select desired Back light mode by "F/F" key.

- WDR SET.

1. WDR LEVEL : LOW

RETURN TO MENU.

WDR SET

- WDR LEVEL: Set up WDR sensitivity, OFF or Low, Middle Max.

- HLC SET.

1. HLC LEVEL : MIDDLE
 2. HLC COLOR : 07

RETURN TO MENU.

HLC (High Light Compensation) SET

- HLC LEVEL: Set-up HLC level LOW, MIDDLE, MAX.
 - HLC COLOR : Adjust HLC marking color level
 1 (White) ~ 16(Black), 8 level is Gray color.

- BLC SET.

1. BLC LEVEL : MIDDLE
 2. BLC AREA SET.

RETURN TO MENU.

BLC SET

- Set up BLC mode or BLC area set by joystick,
 BLC sensitivity level : LOW, MIDDLE, MAX.

- BLC AREA SET

① "2. BLC AREA SET.", enter BLC AREA SET menu by moving joystick left / right.

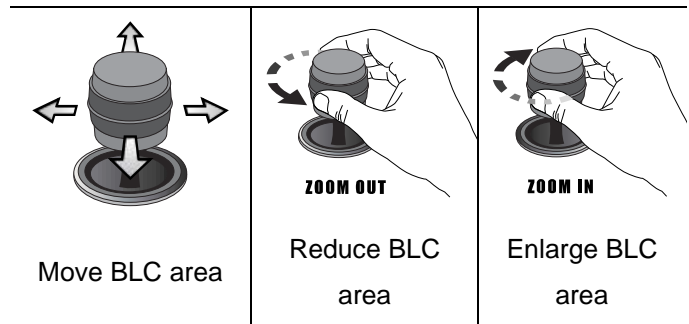
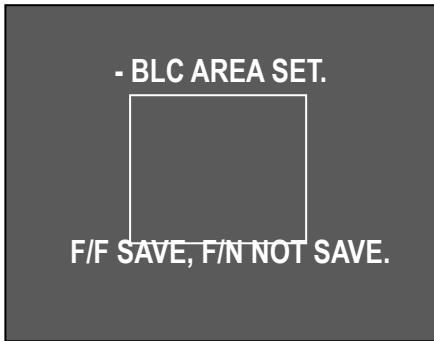

② It is enables to move BLC area, reduce BLC area and enlarge BLC area by Joystick ZOOM IN/OUT

16. WHITE BALANCE

The white balance menus adjusts the balance of the screen colors under different lighting conditions.

- ▶ AUTO, INDOOR, OUTDOOR

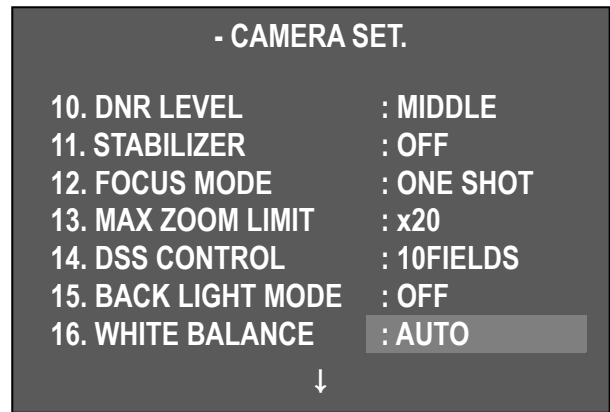

17. NEXT MENU PAGE.

- ▶ Go to next menu page.

18. PREVIOUS MENU PAGE

Back to previous screen.

19. DAY&NIGHT

The Day & Night function allows the camera to switch between color and B/W mode. It is set to optimal condition by DSS control function.

- ▶ NIGHT MODE : B/W Mode most times.
- ▶ AUTO SLOW : Operates in **DAY&NIGHT** mode under low illumination.
- ▶ AUTO FAST : Operates in **DAY&NIGHT** mode high illumination.
- ▶ DAY MODE : COLOR mode most times.

Default is AUTO SLOW, It keeps color mode most times under AUTO SLOW.

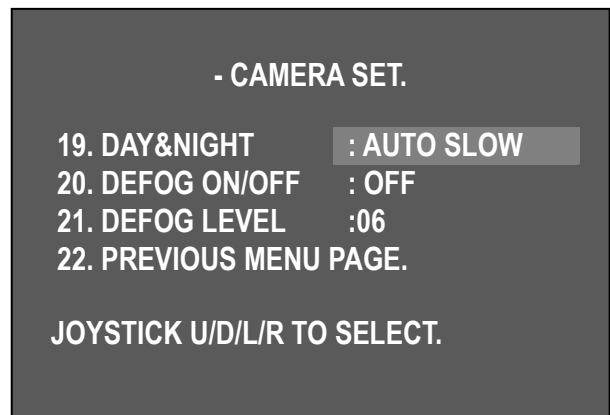

20. DEFOG ON/OFF

DEFOG is the ability to clearly restore the image when the monitor degradation by fog, smog, etc.

- ▶ OFF: Disable this function.
- ▶ MANUAL: user can set defog level.
- ▶ AUTO: DEFOG function will be executed automatically.

21. DEFOG LEVEL

You can adjust sensitivity, when setting defog mode to manual.

- ▶ 1~10: the higher the number , the sensitivity rises.

■ SPECIAL SET

1. OSD DISPLAY

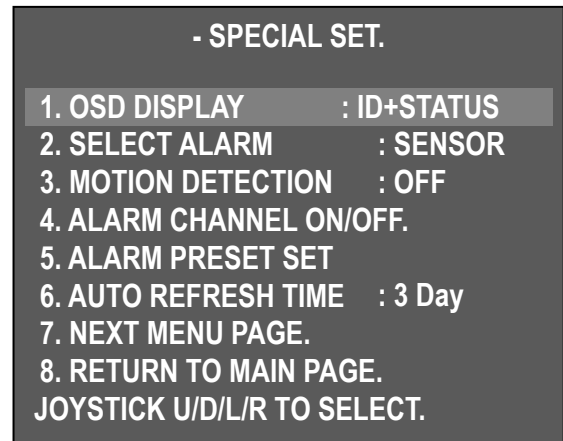
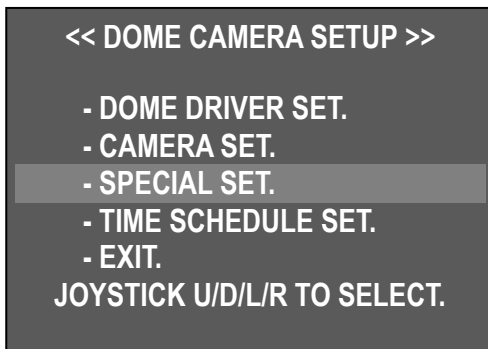

Display ID or Status in the screen

- ID + STATUS: Display 'ID' & 'Status' only
- ID ONLY: Display only 'ID'
- STATUS ONLY: Display 'Status' only
- ALL OFF: None display

Caution) Keep icon in the screen in any condition.

2. SELECT ALARM

Enable to select Alarm sensor type.

- ▶ Sensor / Motion

3. MOTION DETECTION

Detect if the movement is recognized in designated area, it is display "Motion detected" message in the screen and beep sound in the keyboard.

PTZ function doesn't perform when motion detection is "On", Motion detection is detected specific area's movement, if the cameras moves Pan, Tilt and zoom, it doesn't recognize the motion detection correctly.

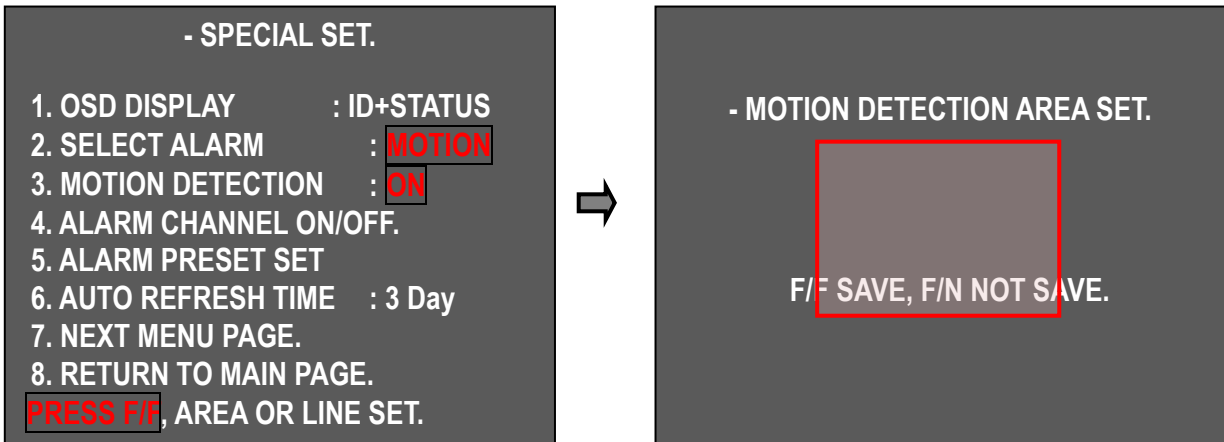

■ Set up motion detection

- ① "2. SELECT ALARM". Select "motion".
- ② "3. MOTION DETECTION" select "ON" Change to screen for motion detection area set mode by pressing F/F key.

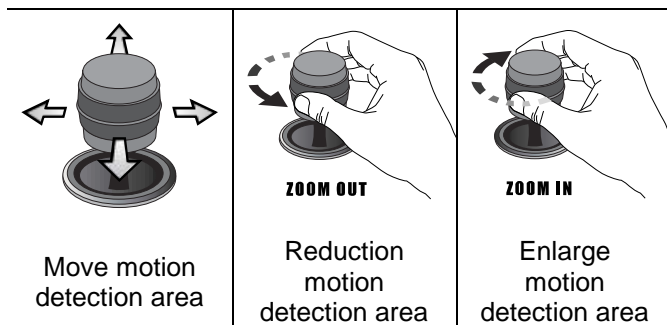

- ③ Set motion detection area by joystick and adjust motion detection area size by joystick Zoom IN/OUT.
- ④ Save motion detection setting and back to previous menu by pressing "F/F".

Select MOTION DETECTION : "On" it is displayed "Motion Detected" message in the screen if motion is detected in designated motion detection area.

4. ALARM CHANNEL ON/OFF

- Set Alarm input On/Off each channel.

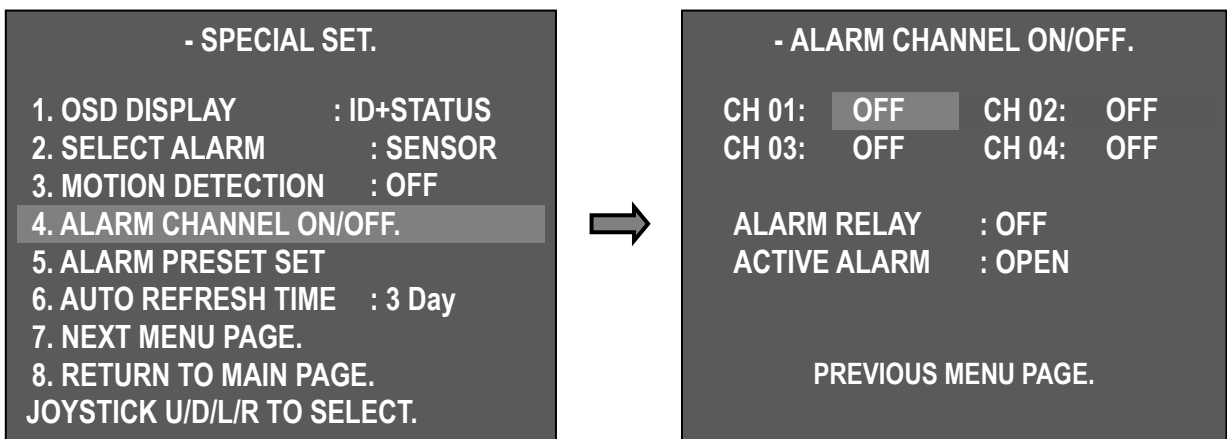

- ALARM CH On/Off : Alarm Input – Each channel can be ON/OFF.
- According to signal connection, user can select ACTIVE OPEN(N/C) or ACTIVE CLOSE(N/O).
- If the user selects ACTIVE OPEN, it is activated when Alarm input is open, if the user selects ACTIVE Close, it is activated when Alarm input is Close

5. ALARM PRESET SET

- The camera can move to a preset point automatically when the wrong signal is sensed in each ALARM CHANNEL.
- Set a preset point firstly to move, if wrong signal is sensed, then use that sets the preset number into each ALARM CHANNEL.
- Select ALARM Channel “OFF” and doesn’t move relevant preset point
- User can select PRESET Point number 1 to 250 and set it.
- It is checked exist Alarm status in the keyboard, if it is sensed wrong signal, the keyboard makes beep sound and the security manager can check Alarm position status.

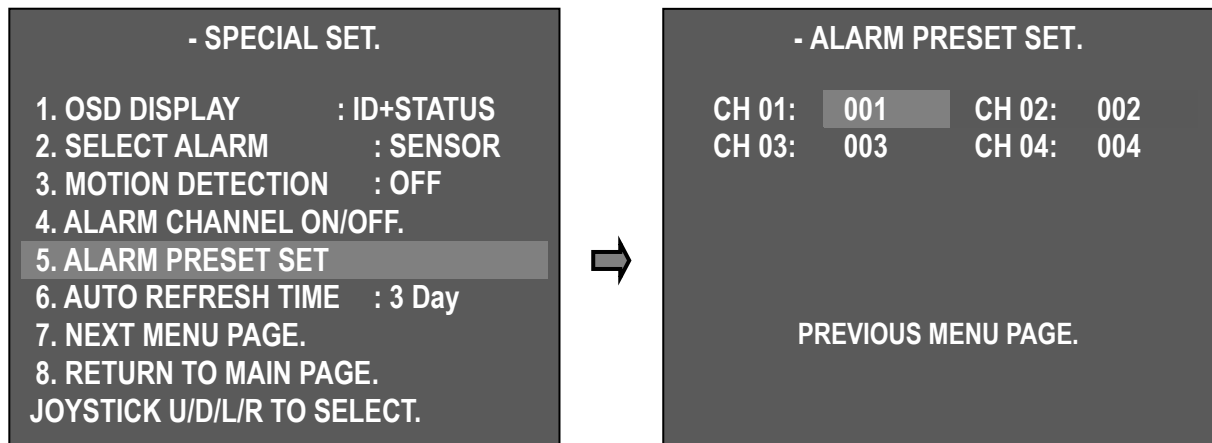

When many cameras' alarm are checked, it might take time to transmit signal to Control keyboard when alarm is detected but the camera moves specific preset position automatically.

Please refer to CONTROL KEYBOARD user manual

6. AUTO REFRESH TIME

- Initialize automatically for focus normal movement.

▶ OFF, 6hours~18hours, 1day~7days.

◆ Focus initialize pressing F/F key

7. NEXT MENU PAGE.

▶ Go to the next page.

8. RETURN TO MAIN PAGE.

▶ Go to previous page.

9. USE SHORTCUT KEY

The Shortcut Key can make some of the functions to perform faster and easily.

- ▶ ON : Use shortcut key
- ▶ OFF : Not use Shortcut key

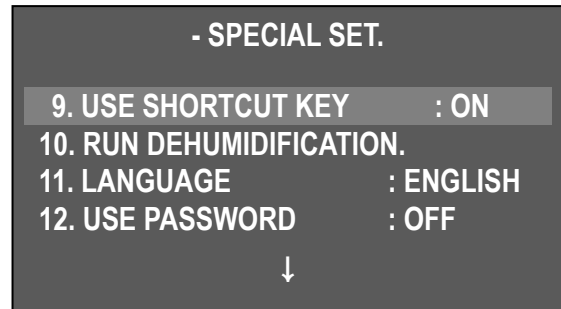

■ Short cut key menu

Function	Operation	Function	Operation
Group 1	51 + Preset	Run Tilt Swing	65 + Preset
Group 2~11	52 ~61 + Preset	Run Trace	66 + Preset
Group 12	62 + Preset	Run Spiral	67 + Preset
Run Tour	63 + Preset	OSD Menu ON/OFF	95 + Preset
Run Pan Swing	64 + Preset		

Caution) it is able to perform the functions in all protocol type

10. RUN DEHUMIDIFICATION

When the camera is installed under hush weather condition, it is hard to monitoring the subject due to moisture condense on the clear glass, to remove Moisture condense, the user can use Dehumidification which operate fan and heater for 10 min. The function stops after activating it for 10min automatically but if you want to use Dehumidification again, you could select the function in the OSD.

- ▶ Turn ON : 1 + AUX1 + ON
- OFF : 1 + AUX1 + OFF

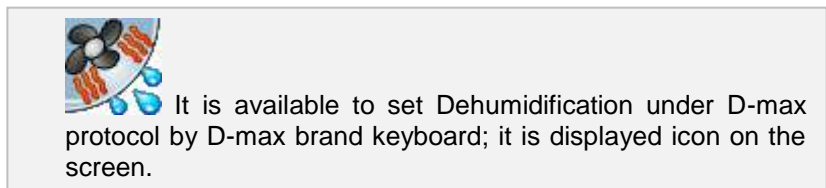

11. LANGUAGE

- Multi-language
- ▶ English, Korean

12. USE PASSWORD

Designate User password for PTZ operation security.

- "12.Select USE PASSWORD" ON/OFF by Joystick
- Select Use password "ON", display Password question in the screen before the user enter OSD menu.

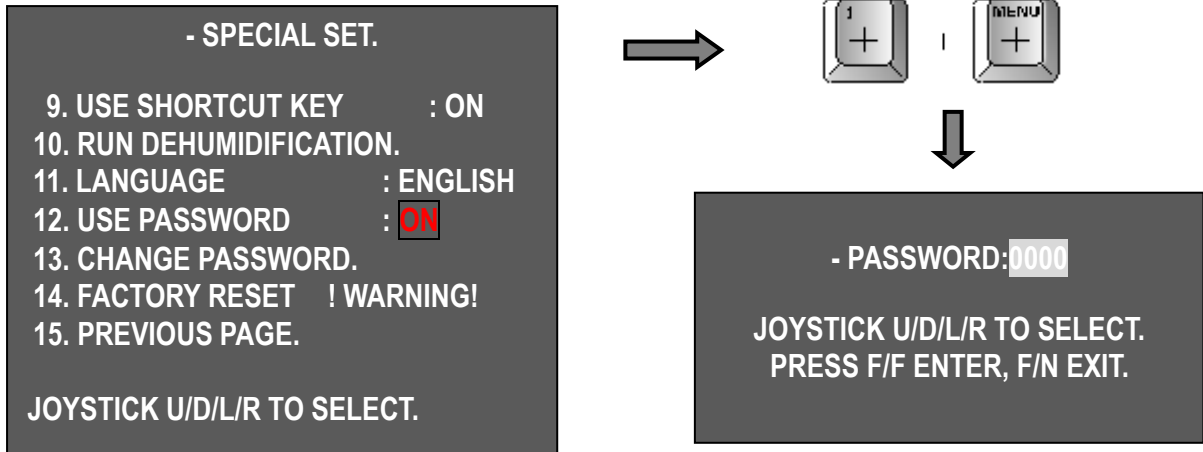

13. CHANGE PASSWORD

- "13. CHANGE PASSWORD" the user can select password by Joystick Left / Right.

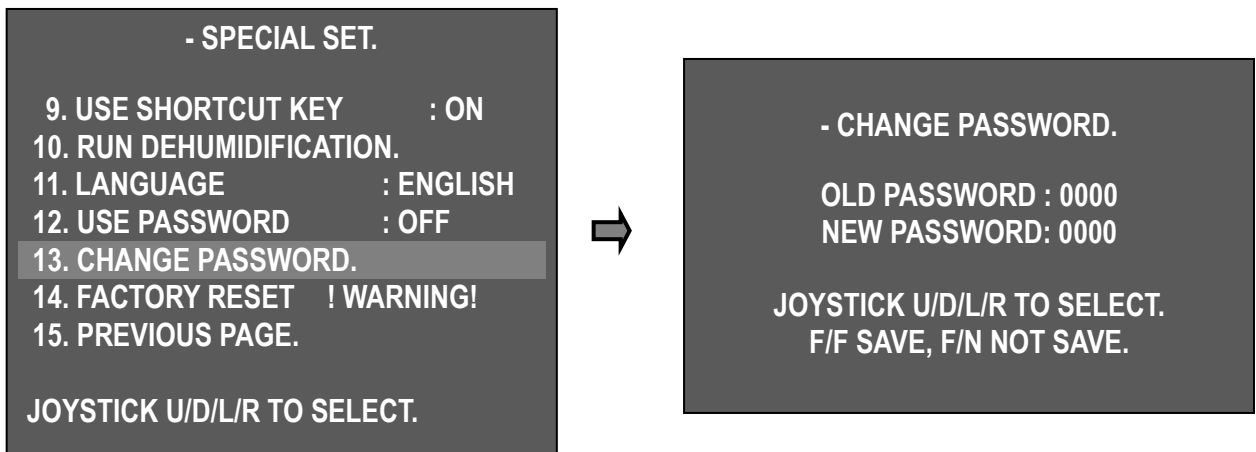

- Initial Password is "0000", New Password is designated by Joystick UP/Down/Left/Right
- F/F key : it saves the password and back to previous menu
- F/N key : it doesn't save Password and back to previous menu

**Caution) if user forget password, it would use Hidden password
 Hidden password: 7233, Please change to Password for security.**

14. FACTORY RESET

Set factory default same as initialization setting.

Caution) Remove exist setting in the menu.

■ TIME SCHEDULE SET

1. SCHEDULE FUNCTION SET

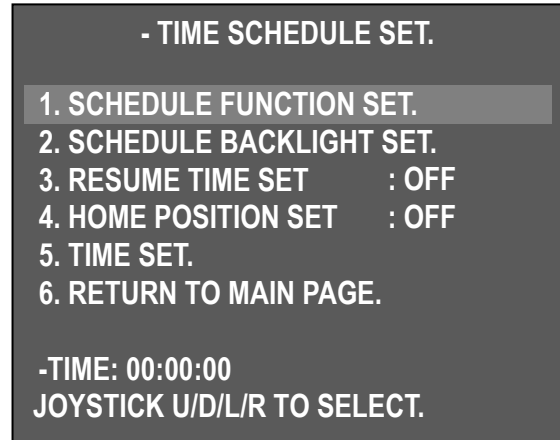
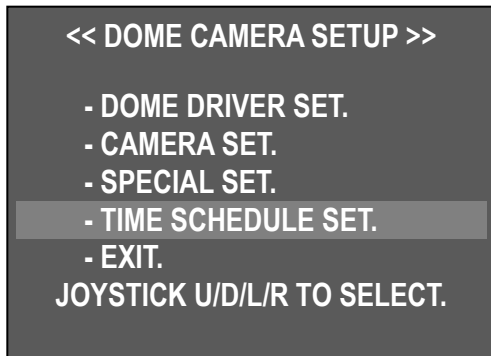

Set to operate the functions for various surveillance, dehumidification, etc., in the designated time.

Select TIME SCHEDULE SET > SCHEDULE FUNCTION SET in order.

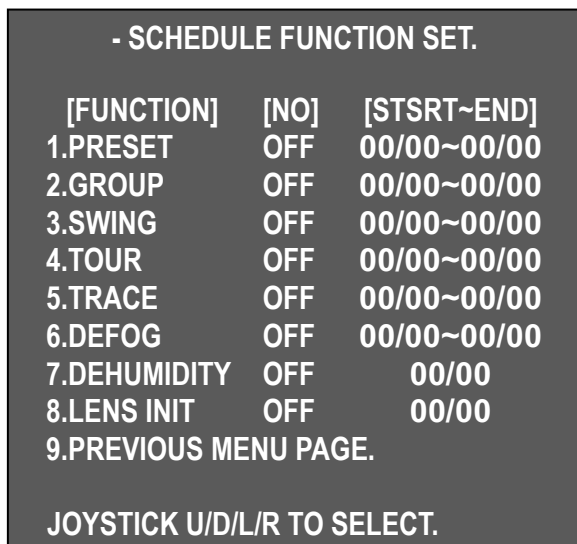

1. Setting PRESET, GROUP & SCHEDULE: Select PRESET or GROUP by moving the Joystick up & down in [FUNCTION]. Select the saved PRESET No. or GROUP No. in [NO] and then set the operating start time and the stop time for PRESET or GROUP in [START~END].

- ※ [START~END] indicates the hour/minute and the time is set within 24 hours.
- ※ PRESET, GROUP, SWING, TOUR, TRACE, DEFOG can be overlapped in [FUNCTION]1~6. Beware of malfunction when time is overlapped.

2. Setting SWING SCHEDULE: Select SWING in [FUNCTION]. Select PAN or TILT in [NO] and then set the operating start time and the stop time for SWING in [START~END].

- ※ Either PAN or TILT can be set for SWING.

3. Setting TOU and TRACE SCHEDULE: Select TOUR or TRACE in [FUNCTION]. Select ON or OFF in [NO] and then set the operating start time and the stop time for TOUR or TRACE in [START~END].

4. Setting DEFOG SCHEDULE: Select DEFOG in [FUNCTION]. Select MANUAL or AUTO in [NO] and then set the operating start time and the stop time for DEFOG in [START~END].

5. Setting DEHUMIDITY(=DEHUMIDIFICATION) SCHEDULE: When the operating start time is set with DEHUMIDITY function 'ON', the fan & heater will work for 10 minutes on time.

※ Use this function in the specific time when the dehumidification is needed.

6. Setting LENS INITIAL SCHEDULE: The zoom and the focus of LENS are initialized in the setting time.
 - Set LENS INIT to 'ON' and then the operating time.

※ LENS INIT is for maintaining the lens in the constantly optimized condition when operating the autofocus function under the optimization of the lens motor.

2. SCHEDULE BACKLIGHT SET

This function makes the set Back Light Compensation worked in the designated time.

- TIME SCHEDULE SET.

1. SCHEDULE FUNCTION SET.
2. SCHEDULE BACKLIGHT SET.
3. RESUME TIME SET : 003
4. HOME POSITION SET : 003
5. TIME SET.
6. RETURN TO MAIN PAGE.

-TIME: 00:00:00
 JOYSTICK U/D/L/R TO SELECT.



- SCHEDULE BACKLIGHT SET.

[BACKLIGHT]	[NO]	[STSRT~END]
1.WDR	OFF	00/00~00/00
2.HLC	OFF	00/00~00/00
3.BLC	OFF	00/00~00/00

4.PREVIOUS MENU PAGE.

JOYSTICK U/D/L/R TO SELECT.

- After adjusting to 'ON' one function to operate for a fixed time among WDR/HLC/BLC and then set the operating start time & the stop time. When operating on SCHEDULE function and stopping, it operates as set in the BACKLIGHT function of CAMERA SET.

※ Beware of malfunction in case the time setting of BACKLIGHT 1,2,3 is overlapped.

3. RESUME TIME SET

It can select the delay time that the camera move to the place alarming to observe where wrong signal is sensed.

User can set it for 1sec to 180sec and operate GROUP, TOUR, SWING again in a preset time. SWING, GROUP, TOUR are operated in a preset time when user stops the operating joystick in the case of not connecting with the ALARM.

- TIME SCHEDULE SET.

1. SCHEDULE FUNCTION SET.
2. SCHEDULE BACKLIGHT SET.
3. RESUME TIME SET : 003
4. HOME POSITION SET : OFF
5. TIME SET.
6. RETURN TO MAIN PAGE.

-TIME: 00:00:00
 JOYSTICK U/D/L/R TO SELECT.



This Icon is displayed in the screen when it is set Resume Time. When Resume time is set, it is not enable to set PRESET, GROUP, TOUR or SWING, If the user want to set the function, Resume time function have to be "OFF" then the user can set the desired function.

4. HOME POSITION SET

This function shows that when the abnormal sign happens in the execution of PRESET in SCHEDULE FUNCTION SET, the camera can move to and surveil Alarm position, and select the staying time. In addition, even after it works manually or the PRESET is run, the executed SCHEDULE PRESET operates again after this setting time. The user can designate the time from 3 to 180 seconds. When the setting time passes, the PRESET of SCHEDULE FUNCTION is run again.

- TIME SCHEDULE SET.

1. SCHEDULE FUNCTION SET.
2. SCHEDULE BACKLIGHT SET.
3. RESUME TIME SET : 003
4. HOME POSITION SET : 003
5. TIME SET.
6. RETURN TO MAIN PAGE.

-TIME: 00:00:00
JOYSTICK U/D/L/R TO SELECT.

EX). When the PRESET of SCHEDULE FUNCTION SET is set to 00:00~23:59, the camera always moves back to home position after the setting time in alarming or manual operation.

5. TIME SET

This function can set the operating time and the time compensation.

- TIME SCHEDULE SET.

1. SCHEDULE FUNCTION SET.
2. SCHEDULE BACKLIGHT SET.
3. RESUME TIME SET : 003
4. HOME POSITION SET : 003
5. TIME SET.
6. RETURN TO MAIN PAGE.

-TIME: 00:00:00
JOYSTICK U/D/L/R TO SELECT.



- TIME SET.

- 1.CHANGE TIME : 00/00/00
2. TIME COMPENSATION : 000S/24H

JOYSTICK U/D/L/R TO SELECT.
F/F SAVE, F/N NOT SAVE.

- When moving the joystick right and left in '5.TIME SET', 'TIME SET' appears on the screen .

- Move Menu or
- Change Setting Value or

1). CHANGE TIME: Set the time in order of hour/minute/second.

2). TIME COMPENSATION: Compensate the time error when operating for a long time. You can set it in seconds, even in positive numbers and negative numbers. (Based on 24 hours)

- After completing the setting, please press F/F key for saving.

ex). 001S/24H → Compensate time one second faster a day(Max. -59 seconds)
 -02S/24H → Compensate time two seconds later a day(Max. -60 seconds)

※ As it's not a network product, time can be changed a little when using it for a long time. After the blackout or one to three-hour power-off, time can be compensated, but when operating again and using it in the long-time power-off, please be sure to check time.

3.4.3. Set-up menu, Execute and delete by keyboard

1. Preset Setting

Save Max. 250 Preset points

① Preset set up



② Preset movement



Move designated preset position after press Preset No and P-SET button.

③ Delete Each Preset



Press button for 3 sec then beep sound, it follows the steps as below.



Ex) Delete No 5 Preset



(Holding 3 seconds)

④ Delete All Preset



Press button for 3 sec then beep sound, it follows the steps as below



(holding 3 seconds)

2. Swing Setting

① Swing set

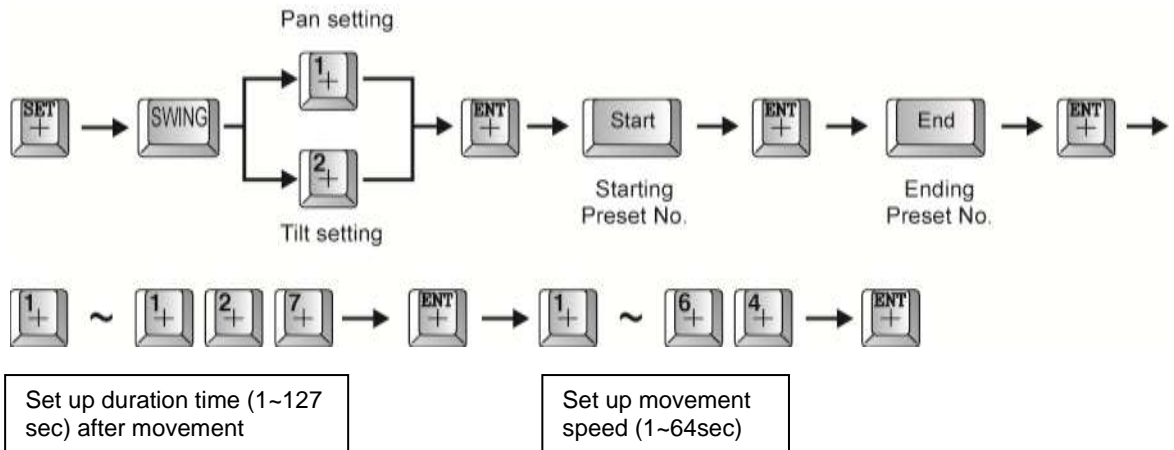

② Swing execute



③ Swing stop

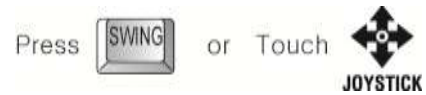

3. Group setting

① Start Group setting mode

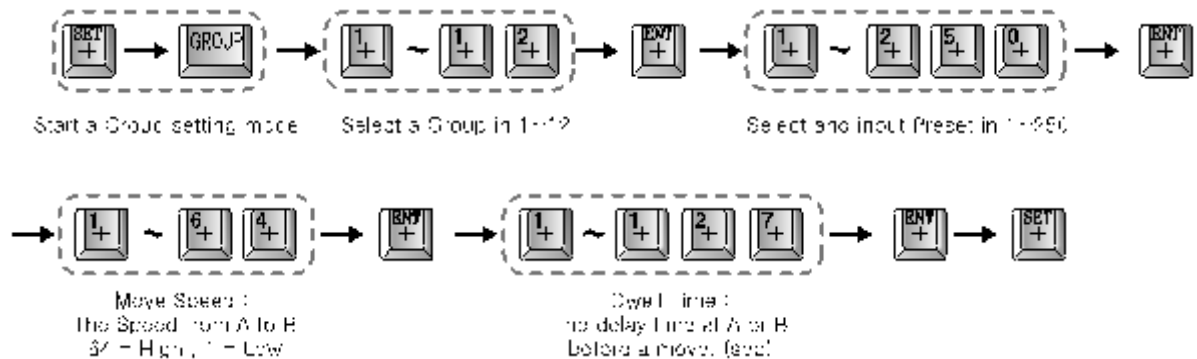

To set more preset, enter preset No and set same process.

Set a GROUP again from the first after ending with , if user wants to finish Preset input in one Group to input another Group.

EX). Register No.4 ~ No.6 as Group No.3 and delay time is 5sec, 64 Move speed.

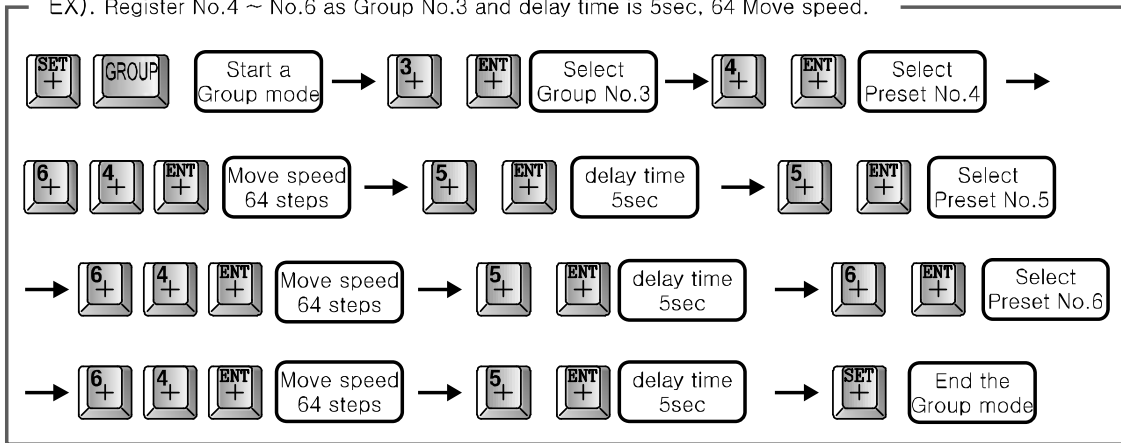

② Group execute



③ Group stop

It can be stopped when user presses or controlling the joystick.



4. Tour setting

① Tour set mode



Start a tour set mode Select a Group in 1 ~ 2 Groups

■ Repeat input in continual input

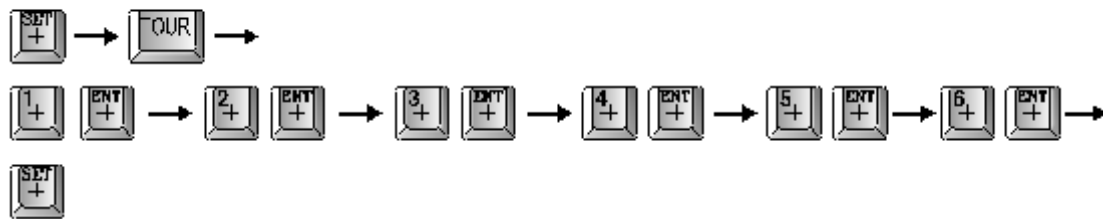

EX). Register Group No. 1,3,6 as Tour

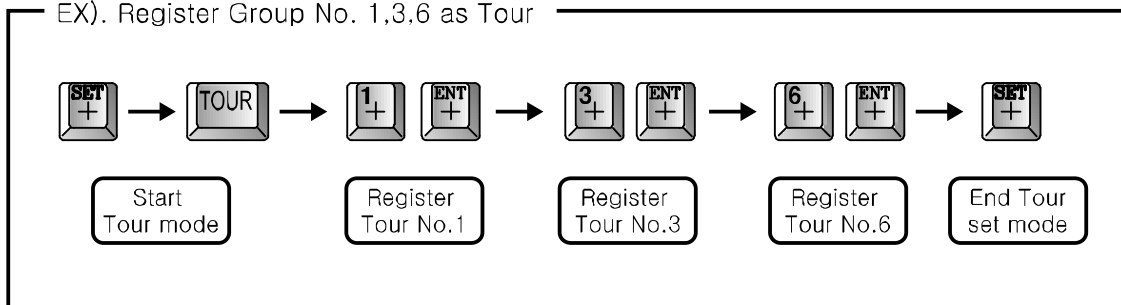

② Tour execute/Stop

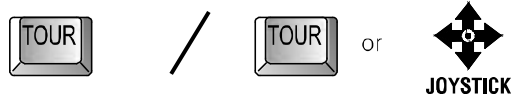

Start Tour

End Tour

③ Tour remove

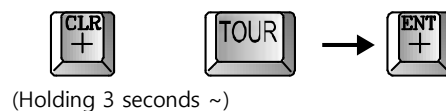

(Holding 3 seconds ~)

5. Spiral Function

It is a function to observe objects automatically in the spiral direction.

① Spiral On



② Spiral Off



* 26. "67+PRESET key" is also available in Shortcut key 'On' mode

6. PTZ Trace

It memorizes P/T/Z motions for 200sec then operates them at the same Trace.

① Trace execute/Stop

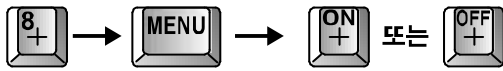

▪ Cancellation:



② Trace setting

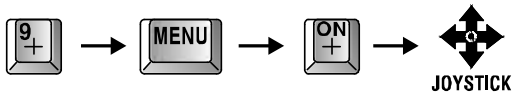

③ Trace Cancellation



Control the joystick and Lens

* 26. "66+PRESET key" is also available in Shortcut key 'On' mode

3.4.4. OSD Message Description

1. PRESET Message

<p>CAM-001</p> <p>SAVE PRESET:001</p>	<p>CAM-001</p> <p>PRESET:001</p>	<p>CAM-001</p> <p>CLEAR PRESET:001</p>
<p>User can check that Preset No.1 is saved as an appeared message in Preset set.</p>	<p>It appears when moving to the preset No.1.</p>	<p>It appears when user deletes PRESET No.1. The message 'All clear PRESET' is displayed when user delete PRESER data all at once.</p>

2. SWING Message

<p>CAM-001</p>  <p>[SWING] PRESET:001</p>	<p>Display SWING execute in the screen.</p>
---	---

3. GROUP Message

<p>CAM-001</p> <p>SET GP:01 P001,T001,S64, CNT01</p>	<p>CAM-001</p> <p>SAVE GROUP:01</p>	<p>CAM-001</p>  <p>[GROUP:01] PRESET:001</p>
<p>As the message in the time of operation of GROUP SET, "GP:01" means group No.1, "P001" means Preset No1, "T001" means duration time 1 sec "S64" means movement speed 64, "CNT01" means set-up preset points (1 group is consist of 12 preset points)</p>	<p>As the message in the time of completion of GROUP SET</p>	<p>It is displayed in the time of operation of Group and preset No.</p>

4. TOUR Message

The diagram shows three camera display screens, each labeled 'CAM-001' at the top. The first screen displays 'Set Tour GP:01'. A callout box below it explains: 'As the message in the time of operation of Tour set, "GP:01" means GROUP No.1 and it shows that GROUP No.1 was saved.' The second screen displays '[TOUR&GP:01] PRESET:001'. A callout box below it explains: 'As the message in the time of operation of Tour RUN, it will show that moving to PRESET No.1 in GRIROUP No.1.' The third screen displays 'CLEAR TOUR&GROUP.'. A callout box below it explains: 'It shows the data in GROUP and TOUR saved was deleted.'

5. SPIRAL Message

The diagram shows a camera display screen labeled 'CAM-001' at the top. The screen displays '[RUN SPIRAL]'. A callout box to the right explains: '-RUN SPIRAL : It is the Message in the time of operation of SPIRAL SEQUENCE. It observe all area of an object in three dimensions that SPIRAL SEQUENCE CAMERA moves to upper then down slowly in a spiral direction.'

4. TROUBLE SHOOTING

CAUTION IN USE

- Make sure that turn the power switch off before installation.
- Avoid the places where is the high/low temperature and humid.
- Power supply must be min AC24V/1A for indoor (DMS-200) and min AC24V/1.5A for outdoor (DMS-200Se)
- Please be careful of that you connect respective wires without mismatching in installation.
- Supply to power sources after checking the state of insulation of cables which is connected to the exterior
- Please keep the product from a strong shock or vibration which is the cause of troubles.

Checking in under using

Check the product as following, if something is wrong in installation or using.

STATUS	CHECK POINT	TROUBLE SHOOTING
Power is not turned on.	Does the electric power supply into the product well?	Check the POWER LED is "ON" at the BOTTOM COVER.
Does not work in Power On.	In operating, does the LED beside POWER SW light on red?	Check the status of DATA CABLE, if it is not lit. Check ADDRESS and DIP SW of communication speed setting, if it is not lit.
	Have you selected to RS485 or RS422 right?	Check the status of OPTION DIP SW No.2
Poor condition of PAN/TILT	Have you turned the ending terminal register 'ON'?	Turn 'ON' the ending terminal register of the camera which is set in farthest away.
A image is not clear or black lines are displayed on the screen.	Is the power adapter AC24V, 1.5A over?	Exchange the adapter to for an adapter which has higher current.
The message 'P/T POSITION ERROR' is displayed continuously.	Is the camera pressed by something heavy or put it between others?	Check that a rotation of the camera's body works smoothly and remove a object that hinders the operation of the camera.
The message 'SORRY NOT MEMORY' is displayed continuously.	Have you set the related functions?	Please refer to the manual book and setting the function you want.
ALARM RELAY is not changed to 'ON' in the state of being alarmed.	Have you set the ALARM RELAY 'ON' in the SET MODE?	Make sure ALARM RELAY 'ON' in the SET MODE.
In abnormal condition, even if the sensor is well.	Is it correct ALARM ACTIVE setting status and the sensor is either opened or closed?	Fit ALARM ACTIVE MODE setting with the connection of the SENDOR in the SET MODE.(It means either sensor is opened or closed)
PRESET point is different or out of moving when the ALARM occurs. The warning does not work from the keyboard when the ARLAM occurs.	Have you set ALARM PRESET in the SET MODE?	Check the status of the ALARM PRESET setting in the SET MODE.
	Have you used the exclusive control keyboard?	The warning is only reacted to the exclusive control keyboard.
	YES.	Make sure ALARM "ON" of the camera.

5. Dimension

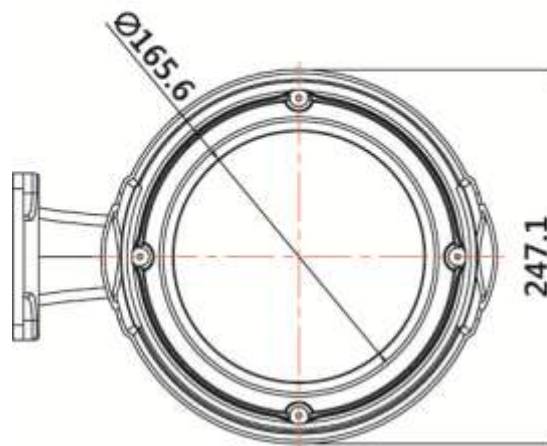
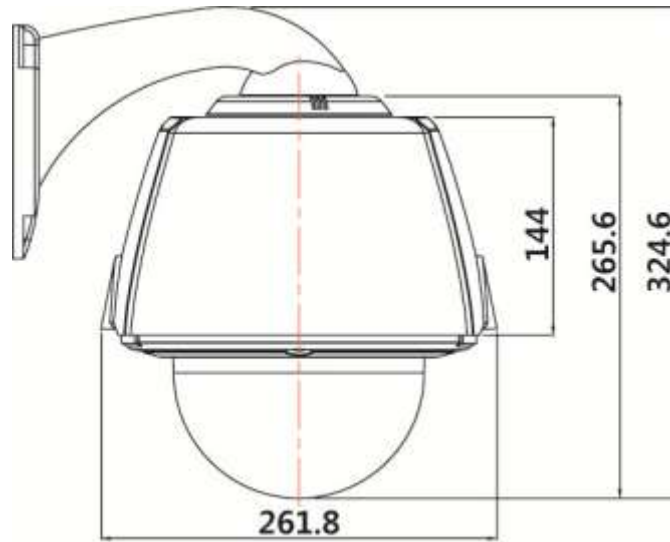

Unit : mm

6. Configuration diagram

■ Camera + DVR + Monitor

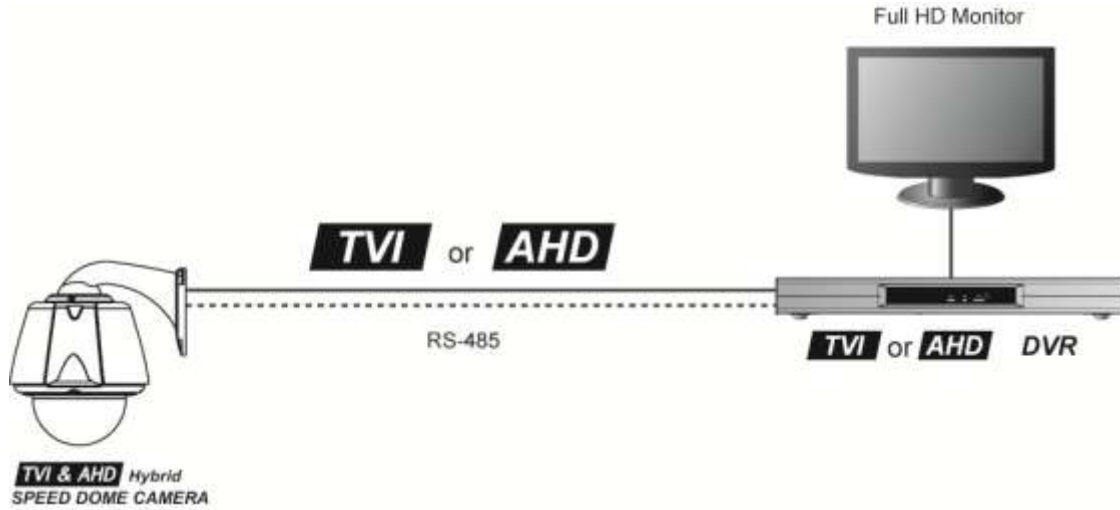

■ Camera + DVR + Monitor + Controller

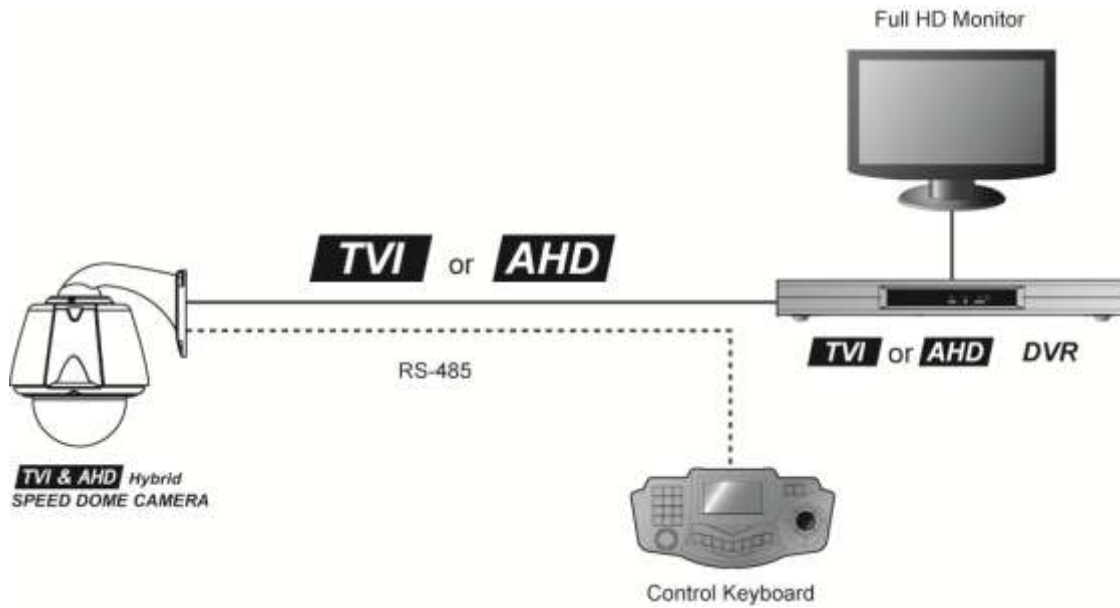

7. Specification

MODEL	TVI & AHD Hybrid Speed Dome Camera
Video	
Image Sensor	1/2.8" 2Mega Sony CMOS
Scan mode	Progressive Scan
Total number of pixels	1952(H) x 1236(V), 2M Pixels
Number of active pixels	1944(H) x 1224(V), 2M Pixels
Resolution	1080p
Minimum illumination	Min 0.0005Lux @ F1.6(50IRE) with Max 60X Sens-up)
Video Output	Main: TVI/AHD Selectable Sub: CVBS
S/N Ratio	More than 52dB
Lens	
Lens	4.45~89mm(20x), F1.6(Wide)/2.9(Tele) Optical(20x), Digital Zoom(16x), Total Zoom (320x)
Focus mode	Auto / Manual / Oneshot
Angle of view	H:62.9°(Wide)~3.1°(Tele), V:43.32°(Wide)~2.34°(Tele)
Pan/ Tilt	
Pan/Tilt angle	360° Endless / 92°
Pan Speed	0.1° ~ 240°/sec (64 Levels), Preset: 360°/sec
Preset Accuracy	±0.1°
Preset point	250 Presets
Alarm in/out	4 Inputs / 1 Relay Output
Function	
Day & Night	Day / Auto / Night
Back Light	HLC / BLC / WDR
White Balance	AUTO / Indoor/ Outdoor
AGC	Low/Middle/Max/Off
DNR	Low/Middle/Max/Off
Defog	Off/Auto/Manual
Privacy / Motion	8 Zones / 1 Zones
Brightness	Level Setting
Color Level	Level Setting
Stabilize	On/Off
Dehumidification	Available
Environment	
Operating Humidity	30 % ~ 90 % RH
Operating Temp.	- 40°C to 50°
Electrical	
Power Consumption	Max 22W
Power Supply	AC24V, 50/60Hz
Mechanical	
Construction	Aluminum body , Clear vandal bubble (PC)
Dimension	261.8(W)X324.6(H)mm
Weight	About 5Kg (Camera Only)

