

# TH2821A

## Portable LCR Meter

**OPERATION MANUAL**

English  
November 2005

## *Contents*

<i>Contents</i> .....	2
How to Contact Us .....	3
Incoming Inspection .....	4
Notes on Use .....	5
Warranty: .....	6
<i>Chapter 1 Overview</i> .....	7
1.1 Introduction.....	7
1.2 Main Functions .....	7
1.3 Specifications .....	9
1.4 Environment Requirements .....	12
<i>Chapter 2 Panel Illustration</i> .....	13
2.1 LCD Display Illustration.....	13
2.2 Keyboard Illustration .....	15
<i>Chapter 3 Operation</i> .....	17
3.1 Power on .....	17
3.2 How to operate .....	18
3.2.1 First Key Functions .....	18
3.2.2 Second Key Functions: .....	20
3.3 Battery recharge .....	30
3.4 Clearing Instruction.....	31
<i>Appendix</i> .....	32

### Incoming Inspection

Inspect the shipping container for damage. The contents of the shipment should be listed as follows. If the contents are incomplete, if there is damage or defect, please contact our company or your nearest Sales and Service Office.

#### Accessories

TH26028 DC Power Adapter	1
TH26027 4 terminal Kelvin test clip leads	1
LH-200H7C rechargeable battery (inside)	1
User Manual	1

#### Options

TH26029 SMD component test fixture

### Notes on Use

- This meter is only for indoor use.
- Turn off the TH2821A while switching the power supply between battery and DC adapter or replacing the battery.
- Although internal circuit protection is provided, DC voltage or current may damage TH2821A. Before you measure a capacitor, be sure the capacitor is fully discharged.
- Charging may disturb measurement result sometimes.
- Nickel Metal Hydride rechargeable battery can be used for the power supply. TH2821A will not work normally when battery voltage is less than 6V.
- The 12V AC to DC adaptor is recommended to be used for TH2821A power supply.
- Perform Open and Short corrections for accurate measurement especially when test fixture is changed.
- The functions locked with password are not accessible by users.

### Warranty:

This instrument product is warranted against defects in material and workmanship for a period of two years from the date of shipment. During the warranty period, Our company will, at its option, either repair or replace products which prove to be defective. For warranty service or repair, this product must be returned to a service facility designated by our company.

### Warranty limitation

The foregoing warranty shall not apply to defects resulting from improper or inadequate maintenance by Buyer, Buyer-supplied software or interfacing, unauthorized modification or misuse, or improper site preparation or maintenance.

# Chapter 1 Overview

Thank you for purchasing our product. To get the maximum performance from the instrument, please read this manual first, and keep this manual at hand.

## 1.1 Introduction

TH2821A is a microprocessor-controlled portable meter with low power consumption. It can measure six basic parameters, they are inductance  $L$ , capacitance  $C$ , resistance  $R$ , impedance  $|Z|$ , dissipation factor  $D$  and quality factor  $Q$ . TH2821A can fulfill the measurement needs of various component manufacturers and maintenance technicians.

## 1.2 Main Functions

### 1. Test Parameter

L-Q, C-D, R-Q and Z-Q.

### 2. Correction

OPEN: multi-frequency correction of open circuit;

SHORT: multi-frequency correction of short circuit.

### 3. Display Mode

Direct — direct measurement value;

$\Delta$  — absolute deviation;

$\Delta\%$  — percent deviation.

### 4. Range Hold

When measuring a large number of components with the same nominal value, this function can effectively improve the measuring rate.

5. **Comparator Function**  
Built-in 4 Bins comparator: NG, P1, P2 and P3.
6. **Equivalent Circuit Mode**  
Both parallel and series equivalent circuit modes can be obtained.
7. **Data Hold**  
This function can be used to freeze the current display value.
8. **Alarm Mode**  
NG, P1, P2, P3 and OFF modes can be selected.

## 1.3 Specifications

Parameter	L-Q, C-D, R-Q and Z-Q		
Frequency	100 Hz, 120 Hz , 1 kHz and 10 kHz		
Accuracy	Basic Accuracy: 0.3%		
Display	5 digits display for both primary and secondary parameters		
Measurement Range	L	100 Hz, 120 Hz	1 $\mu$ H - 9999 H
		1 kHz, 10 kHz	0.1 $\mu$ H - 999.9 H
	C	100 Hz, 120Hz	1 pF - 9999 $\mu$ F
		1kHz, 10 kHz	0.1 pF - 999.9 $\mu$ F
	R,  Z	0.0001 $\Omega$ - 999.9 M $\Omega$	
	D, Q	0.0001 - 9999	
	$\Delta\%$	0.0001% - 9999%	
Test Level (Range Auto and Open Circuit)	10kHz	0.1 Vrms (1 $\pm$ 15%)	
	120Hz 1kHz	0.3 Vrms (1 $\pm$ 15%)	
	100Hz	0.42 Vrms (1 $\pm$ 15%)	
Ranging Mode	Auto and Hold		
Equivalent Circuit	Parallel and Series		
Display	Direct, $\Delta$ ABS and $\Delta\%$		
Correction	Open and Short Zeroing		
Rate	Approx. 3 meas/sec		
Terminals	5 terminals		



## TH2821A OPERATION MANUAL

(Continued)			
<b>Comparator</b>	4 Bins: NG, P1, P2 and P3		
<b>Limit Setup Range</b>	$\Delta\%$	-9999% - 99999%	
	<b>Nominal</b>	L	0.0001 $\mu$ H - 99999 H
		C	0.0001 pF - 99999 $\mu$ F
		R	0.0001 $\Omega$ - 99999 M $\Omega$
		Z	0.0001 $\Omega$ - 99999 M $\Omega$
<b>Alarm Mode</b>	NG, P1, P2, P3 and OFF		
<b>Power Supply</b>	9V rechargeable battery or DC12V(100 mA) adapter		
<b>Low Battery Indication</b>	Approx. 6V		
<b>Power Consumption</b>	Normal: Approx. 25 mA Auto power-off: Approx. 500 nA		
<b>Auto Power Off time</b>	Approx. 5 minutes		
<b>Weight</b>	Approx. 400 g		
<b>Dimensions</b>	200mm(L) $\times$ 95mm(W) $\times$ 40mm(D)		

**Table 1-1 Specifications**

 **Note :**

Primary parameter accuracy( $A_e$ )

$$C: A_e = 0.3\%(1 + C_x/C_{max} + C_{min}/C_x)$$

$$L: A_e = 0.3\% (1 + L_x/L_{max} + L_{min}/L_x)$$

$$Z: A_e = 0.3\% (1 + Z_x/Z_{max} + Z_{min}/Z_x)$$

$$R: A_e = 0.3\%(1 + R_x/R_{max} + R_{min}/R_x)$$

Max and Min values are as follows:

Parameter	Range Auto
$C_{max}$	80 $\mu$ F/f
$C_{min}$	150pF/f
$L_{max}$	159H/f
$L_{min}$	0.32mH/f
$Z_{max}$	1M $\Omega$
$Z_{min}$	1.59 $\Omega$

Here:  $Z_{max} = R_{max}$ ;  $Z_{min} = R_{min}$ , Frequency unit: kHz.

Secondary parameter accuracy

$$D_e = A_e/3 \quad \text{when } D_x \leq 0.1$$

$$D_e = A_e(1 + D_x)/3 \quad \text{when } D_x > 0.1$$

$$Q_e = \pm \frac{Q_x \times D_e}{1 \mu Q_x \times D_e} \quad \text{when } Q_x \cdot D_e < 1$$

## 1.4 Environment Requirements

1. Please do not operate TH2821A under the following environment conditions, as any of them will directly affect measuring precision or damage the meter:
  - *Please do not operate the instrument in places where is dusty, vibrant, under direct sunlight, or where there is corrosive air.*
  - *Although TH2821A has been specially designed for reducing the noise caused by AC power, the environment with low noise is still recommended. If this can not be arranged, please make sure to use power filter for the AC-DC adaptor.*
2. The TH2821A must be operated under the following environment conditions:  
Temperature: 0°C ~ 40°C,  
Humidity:  $\leq 90\%$  RH at 40°C.
3. Storage Temperature: -25°C ~ 50°C.

## 2.1 LCD Display Illustration

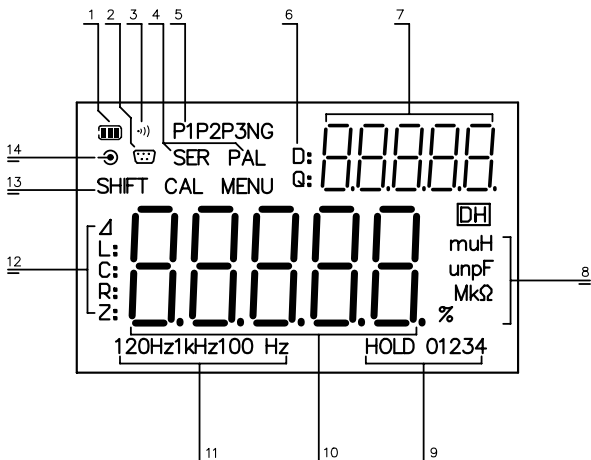

Figure 2-1 LCD Display

No.	Description	No.	Description
1	Battery Power Indicator	8	Unit Indicator
2	Remote Indicator	9	Ranging Mode Indicator
3	Beeper Indicator	10	Primary Parameter Display
4	Series/Parallel Indicator	11	Frequency Indicator
5	Comparator Indicator	12	Primary Parameter Indicator
6	Secondary Parameter Indicator	13	2 <sup>nd</sup> Function Indicator
7	Secondary Parameter Display	14	DC Adaptor Power Supply Indicator

Table 2-1 LCD Description

**Others:**

**DH**: Data hold indictor

**CAL**: Correction function indictor

**MENU**: Menu operation indictor

## 2.2 Keyboard Illustration

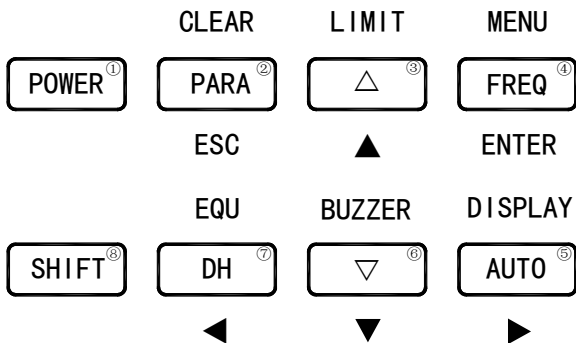





Figure 2-2 Keyboard

### Convention :

#### Key Function Conventions

- 1<sup>st</sup> function: 
- 2<sup>nd</sup> function: 
- 3<sup>rd</sup> function: 

No.	Key	Function	SHIFT+ Key	Function
①	POWER	Power On/Off		
②	PARA	Parameter Selection	CLEAR	Correction key
③	△	Range Up	LIMIT	Sorting Limit Setup
④	FREQ	Frequency Selection	MENU	Auxiliary Menu
⑤	AUTO	Range Auto Selection	DISPLAY	Display Mode Selection
⑥	▽	Range Down	BUZZER	Alarm Mode Setup
⑦	DH	Data Hold	EQU	Equivalent Circuit
⑧	SHIFT	2 <sup>nd</sup> Function		

Table 2-2 Key Description

The 3<sup>rd</sup> Functions:

Esc, ↓, →, ↑, ← and Enter are valid during Menu setup and Data input operations.

### 3.1 Power on

1. Press **POWER** key to turn on TH2821A.
2. The operation system version will be displayed.
3. At last the instrument enters the measurement state.

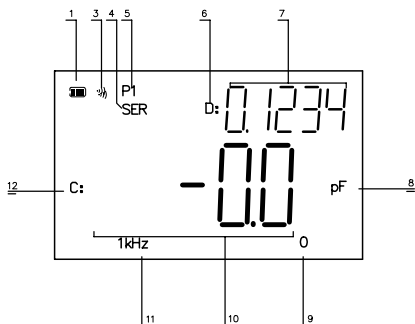

Figure 4-1 Measurement Display

#### Measurement display description:

- |                       |                        |
|-----------------------|------------------------|
| 1. Battery Supply     | 3. Beeper ON           |
| 4. Series Circuit     | 5. Sorting Result: P1  |
| 6. Parameter D        | 7. Secondary parameter |
| 8. Unit               | 9. Range 0 (Auto)      |
| 10. Primary parameter | 11. Frequency: 1 kHz   |
| 12. Parameter C       |                        |



## 3.2 How to operate

### 3.2.1 First Key Functions

#### 1. Parameter Setup:

Press **PARA** key to select the following measurement parameter combinations: L-Q, C-D, R-Q and Z-Q.

Units Description:

L	$\mu\text{H}$	mH	H
C	pF	nF	$\mu\text{F}$
R/ Z	$\Omega$	k $\Omega$	M $\Omega$

Table 4-1 Units

|Z| is the absolute value of impedance. Measurement value of L, C or R may be positive or negative. Negative capacitance value means that the device under test is actually an inductor; also negative inductance value means that the device under test is actually a capacitor. In theory R should be positive constantly, under some condition, R may be negative due to over zero correction. Please carry out correct zero correction.

The maximum number of display digits is 5, but 5-digit is not always available and 4-digit is displayed sometimes.

The conversion is described in the following description:

From 4-digit to 5-digit:

When the first 2 digit of current value is less than 18.

From 5-digit to 4-digit:

When the first 2 digit of current value is more than 20.

#### 2. Frequency Setup:

Use **FREQ** key to select the following test frequencies in turn: 100 Hz, 120 Hz , 1 kHz and 10 kHz.

## 3. Range Setup:

$\triangle$ ,  $\nabla$  and **AUTO** keys are used to set the measurement range. **AUTO** key toggles ranging mode between "Auto" and "Hold".  $\triangle$  and  $\nabla$  keys are used to increase or decrease the measurement range, if the current ranging mode is "Auto", then the ranging mode is changed to "Hold" at the same time.

 **Note :**

When ranging mode is set to HOLD, the measurement range is fixed at current range. Overload symbol "----" will be displayed if the impedance under test exceeds the current effective measurement range or display range.

Range No.	Range Resistor	Range Up	Range Down
0	100k $\Omega$	$\uparrow$ 20k $\Omega$	$\downarrow$ 18k $\Omega$
1	10k $\Omega$	$\uparrow$ 2k $\Omega$	$\downarrow$ 1.8k $\Omega$
2	1k $\Omega$	$\uparrow$ 200 $\Omega$	$\downarrow$ 180 $\Omega$
3	100 $\Omega$	$\uparrow$ 20 $\Omega$	$\downarrow$ 18 $\Omega$
4	20 $\Omega$	$\uparrow$	$\downarrow$

**Table 4-2 Ranges**

 **Note :**

How to calculate the measurement range

Example: Assume capacitance  $C=210\text{pF}$ , dissipation  $D=0.0010$  and test frequency  $f=1\text{ kHz}$ .

Solution:

$$Z_x = R_x + \frac{1}{j2\pi f C_x}$$

$$|Z_x| \approx \frac{1}{2\pi f C_x} = \frac{1}{2 \times 3.1416 \times 1000 \times 210 \times 10^{-9}} \approx 7579\Omega$$

From the Table 4-2, we can get the correct measurement range is No. 2.

#### 4. Data Hold

Press **[DH]** key to freeze the display, press **[DH]** key again to release.

### 3.2.2 Second Key Functions:

#### 1. Correction Function

- Press **[Shift]** key to select the second function, "SHIFT" will be lighted on the screen.
- Press **[CLEAR]** key to enter the correction function, the following information will be displayed on the screen.

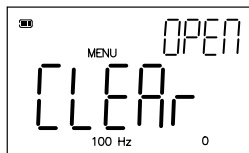



Figure 4-2 Correction Display

## TH2821A OPERATION MANUAL

- *CLEAR* (Clear) is displayed in the primary parameter display area, *OPEN* (OPEN), *Short* (Short) or *Quit* (Quit) will be displayed in the secondary parameter display area.

 **Note :**

*OPEN* (OPEN), *Short* (Short) and *Quit* (Quit) are selected and displayed automatically by the meter according to the impedance value of the device under test.

- Press  key to cancel the correction operation and return to the measurement state. Press  key to start the correction measurement.
- When correction measurement is finished, PASS or FAIL will be displayed on the screen, see Figure 4-3

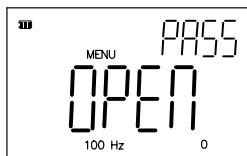



Figure 4-3 Open correction Passed

- Press  key to abort the current correction data measurement and return to the measurement. The previous correction data will still be stored.

 **Note :**



1. The correction function must be used for accurate measurement. The correction function can eliminate the stray admittance (capacitance, and inductance) and the residual impedance (resistance and reactance) induced by test fixture, test leads and

## TH2821A OPERATION MANUAL

instrument itself. Perform the correction operation again if the measurement conditions are changed such as test fixture and environment temperature.

- 2 . It is recommended to perform the open and short correction at the same time.
- 3 . During short correction period, *FAIL* (FAIL) will be displayed in the secondary parameter display area when short correction is failed. Make sure that the measurement contacts are shorted reliably and perform the short correction again.
- 4 . TH2821A measures the correction data at all frequency points and all measurement ranges. The correction data is stored in the non-volatile memory. So you don't have to perform the correction again, if the test conditions are not changed.
- 5 . Open and short corrections are automatically selected by the instrument according to the impedance value under test. If there is a component in the fixture or if there is error with the instrument, *Quit* (Quit) will be displayed in the secondary parameter display area.

### 2. Equivalent Circuit

- Press  key to select the second function, "SHIFT" will be lighted on the screen.
- Press  key to select the Series or Parallel circuit mode. (Refer to Figure4-1)

#### Note :

- 1 . The actual C, R and L are not the ideal pure C, R and L. Normally an actual component can be regarded as the combination of an ideal resistor and an ideal reactor in series or parallel circuit mode.
- 2 . TH2821A can convert between the two different equivalent circuit modes using the following equations. The measurement values of the two different circuit modes maybe different under different quality factor Q (or dissipation factor D).

Capacitance  $C_p$ : from parallel to series

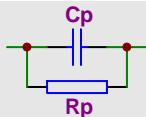

Circuit Mode :

Dissipation : 
$$D = \frac{1}{2\pi f C_p R_p} = \frac{1}{Q}$$

Series : 
$$C_s = (1 + D^2) C_p$$
  

$$R_s = R_p D^2 / (1 + D^2)$$

Capacitance  $C_s$  : from series to parallel

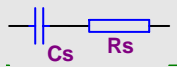

Circuit Mode :

Dissipation: 
$$D = 2\pi f R_s C_s = \frac{1}{Q}$$

Parallel: 
$$C_p = 1 / (1 + D^2) C_s$$
  

$$R_p = R_s (1 + D^2) / D^2$$

Inductance  $L_p$  : from parallel to series

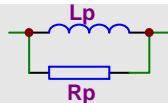

Circuit Mode :

Dissipation: 
$$D = \frac{2\pi f L_p}{R_p} = \frac{1}{Q}$$

Series: 
$$L_s = 1 / (1 + D^2) L_p$$
  

$$R_s = R_p D^2 / (1 + D^2)$$

Inductance  $L_s$  : from series to parallel

Circuit Mode :

Dissipation : 
$$D = \frac{R_s}{2\pi f L_s} = \frac{1}{Q}$$

Parallel: 
$$L_p = (1 + D^2)L_s$$

$$R_p = R_s(1 + D^2)/D^2$$

Here parameter with subscript s means the series mode, parameter with subscript p means the parallel mode.

- From the above equations, we can conclude that the conversion between series and parallel is determined by  $D^2$  or  $Q^2$  ( $Q=1/D$ ). The value of  $D^2$  or  $Q^2$  directly determined the parameter values in different circuit mode.

Example:

Three capacitors have the same series capacitance:  $C_s=0.1\mu\text{F}$ , but their dissipations are different with each other:  $D_1=0.0100$ ,  $D_2=0.1000$ ,  $D_3=1.0000$ . According to the above equation, we can get their capacitance in parallel mode:

$$C_{p1} = 0.09999 \mu\text{F}$$

$$C_{p2} = 0.09901 \mu\text{F}$$

$$C_{p3} = 0.05000 \mu\text{F}$$

We can find that  $C_s$  is almost the same with  $C_p$  when  $D$  is very small ( $D < 0.01$ ), but when  $D$  is more than 0.01,  $C_p$  and  $C_s$  are different obviously. For example: When  $D = 0.1$ , the difference is 1%, but when  $D = 1$ , the difference is almost 50%.

### 3. Alarm Setup

- Press Shift key to select the second function, "SHIFT" will be lighted on the screen.

- Press **BUZZER**, the following information will be displayed on the LCD screen:



Figure 4-4 Alarm Setup

- Use and keys to select following alert modes in turn.
  - OFF* Alert off
  - P1* P1 alert mode
  - P2* P2 alert mode
  - P3* P3 alert mode
  - NG* NG alert mode
- Press to save the alert setup and return to the measurement state.
- press to abort the alert setup without change.

#### 4. Display Mode

- Press key to select the second function, "SHIFT" will be lighted on the screen.
- Press **DISPLAY** key to select the display mode: Direct, Absolute deviation ( $\Delta$ ) , Percent deviation ( $\Delta\%$ ) .

**Note :**

- 1 . Absolute deviation ( $\Delta$ ) display mode



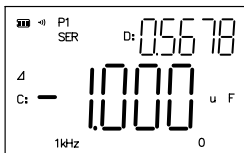

Figure 4-5 Absolute deviation ( $\Delta$ ) display mode

$$\Delta = X_x - X_{std}$$

Where  $X_x$  is the measurement value,  $X_{std}$  is the standard value.

2 . Percent deviation ( $\Delta\%$ ) display mode

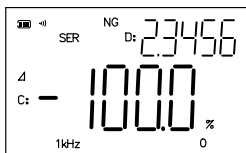

Figure 4-6 Percent deviation ( $\Delta\%$ ) display mode.

$$\Delta\% = \frac{X_x - X_{std}}{X_{std}} \cdot 100\%$$

## 5. Sorting Setup

### Key Convention :













Key	Main Menu	Data Input
	Select the former item	Select the left digit
	Select the next item	Select the right digit
	Select parameter for $5\text{kHz}$ setup	Increase the digit, move the point left and set the unit
	Select parameter for $5\text{kHz}$ setup	Decrease the digit, move the point right and set the unit
	Enter the sub menu	Confirm the data input, and return to the main menu
	Return to the measurement state	Return to the main menu

Table 4-4 Key convention in sorting setup

- Press  key to select the second function, "SHIFT" will be lighted on the screen.
- Press  to enter the sorting setup,  $P1^-$  will be flashing on the screen, and the value of  $P1^-$  is also displayed.
- Use ,  to select the following sorting parameters:
  - $P1_-$ : Low limit of P1
  - $P1^-$ : High limit of P1
  - $P2_-$ : Low limit of P2
  - $P2^-$ : High limit of P2
  - $P3_-$ : Low limit of P3
  - $P3^-$ : High limit of P3

$Q_{-}$ : Low limit of Q  
 $D_{+}$ : High limit of D  
 $Std$ : Standard value

- Press  key to abort the sorting setup and return to the measurement state.
- Press  key to select a parameter and enter the data input operation.

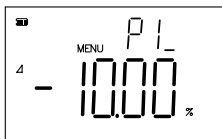

Figure 4-7 Sorting Limit Setup













- Use ,  keys to select a digit or the point.
- Use ,  keys to set the numeric value.
- Press  to return to the main menu.
- Press  to confirm and save the numeric data.
- Select parameter STD to set the standard Value.



Figure 4-8 Standard Value Setup

- Use ,  keys to select a digit, the point or the unit.
- Use ,  keys to set the numeric data and unit.
- Press  to return to the main menu.

- Press  to confirm and save the numeric data.

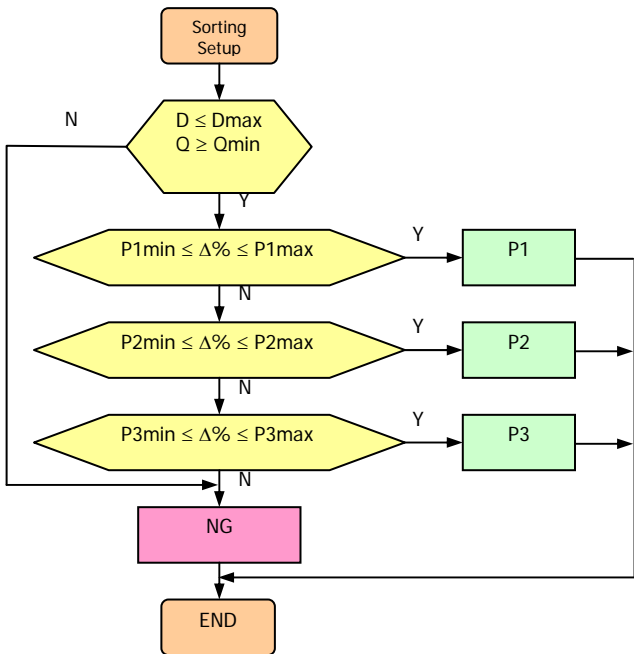











Figure 4-8 Sorting Flow Chart

### 6. Other Functions:

- Press  key to select the second function, "SHIFT" will be lighted on the screen.
- Press  key, APO will be flashing on the screen. Current delay time is also displayed.
- Press  key to enter the auto power off function setup, current delay time flashes on the screen.
- Use ,  keys to select 5', 10', 20', 30' or OFF.
- Press  key to confirm the current delay time and return to the main menu.

#### Note :

When an external DC adapter is used, APO function is disabled automatically.

- Use ,  keys to select "CAL" function.
- Press  key to enter the calibration function. This function is protected with password and is not available for users.

### 3.3 Battery recharge

#### Note :

The instrument will not be started, when the battery is weakening. Recharge the battery immediately by using DC Adaptor Power Supply.

- Battery Power Indicator will flash when charging.

- Charging may disturb measurement result sometimes.
- The battery must be 9V series Nickel Metal Hydride rechargeable battery. For example GP20R8H and LH-2007HC. ◦
- 2~3 hours for charging and 5~6 hours for using.

### 3.4 Clearing Instruction

To clean the instrument, use a soft cloth slightly dipped in water. Do not spray cleanser directly onto the instrument, since it may leak into the cabinet and cause damage. Do not use chemicals containing benzine, alcohol or aromatic hydrocarbons.

## Appendix

### Message Code Table:

<i>CLEAR</i>	Clear: Correction
<i>OPEN</i>	Open: Open correction
<i>Short</i>	Short: Short correction
<i>P1<sup>+</sup></i>	P1 <sup>+</sup> : High limit of P1 Bin
<i>P1<sub>-</sub></i>	P1 <sub>-</sub> : Low limit of P1 Bin
<i>NG</i>	NG: No-Good
<i>Q<sub>-</sub></i>	Q <sub>-</sub> : Low limit of quality factor
<i>D<sup>+</sup></i>	D <sub>-</sub> : High limit of dissipation factor
<i>Std</i>	Std: Standard value (Nominal value)
<i>APO</i>	APO: Auto Power Off
<i>CAL</i>	CAL: Accuracy Calibration
<i>PSd</i>	PSD: Password
<i>ALERT</i>	Alert
<i>ON</i>	ON
<i>OFF</i>	OFF
<i>PASS</i>	Pass
<i>FAIL</i>	Fail
<i>Quit</i>	Quit