

MODEL NO. : LRM-1022

□ SPECIFICATION □

◆ DISPLAY SCREEN

SIZE	10.4 INCH
Active Area	211.2(W)x 158.34mm (H)
ELEMENT	COLOR TFT LCD
RESOLUTION	800 x 600 SVGA
DOT PITCH	0.264 (W) x 0.264 (H)mm

◆ POWER SOURCE

DC 12V

◆ POWER CONSUMPTION

10W Typ.

◆ OPERATING TEMPERATURE

0°C ~ 50°C

◆ STORAGE TEMPERATURE

-20°C ~ 60°C

◆ BRIGHTNESS

230 CD/m²

◆ CONTRAST

500 : 1

◆ OPTICAL RISE TIME / FALL TIME

10/25 Typ.

◆ RESPONSE TIME

10 ms

◆ VIEWING ANGLE

Vertical +35° /-65° , Horizontal : ±60°

◆ PC INPUT

RGB Analogue Input 15 Pin D-sub x 1

◆ VIDEO INPUT

1V_{pp} 75Ω RCA x 1 , S-Video x 1

◆ PLUG & PLAY

VESA DDC2B

◆ GREEN FUNCTION

VESA DPMS

◆ OSD CONTROL FUNCTION

Brightness, Contrast, Color, Volume, Mute

◆ DIMENSION (W x H x D)

489.0 x 220.0 x 51.0 mm

◆ WEIGHT

4000 ± 10 g

□4" LCD SCREEN SPECIFICATION □

◆ DISPLAY SCREEN	SIZE	4 INCHES (10 cm)
	ACTIVE AREA	82.1(W) x 61.7 (H)
	ELEMENT	COLOR TFT LCD
	RESOLUTION	480(W)X234(H)
	DOT PITCH	0.171(W) x 0.264 (H)
◆ VIDEO SYSTEM	NTSC and PAL	Auto-switch
NTSC	f_H : 15.75 Khz	PAL f_H : 15.625 Khz
	f_V : 60 Hz	f_V : 50 Hz
	f_C : 3.58 MHz	f_C : 4.43 MHz
◆ VIDEO INPUT		1Vpp 75 Ohm
◆ POWER CONSUMPTION		12V, 250 mA , 3W Max.
◆ POWER SOURCE		DC 12V
◆ CONTRAST		150 : 1
◆ BRIGHTNESS		250 cd/m ²
◆ VIEWING ANGEL :		Vertical +30 / -10, Horizontal ±45
◆ RANGE OF OPERATING VOLTAGE	DC 9 ~ DC 13V	
◆ OPERATING TEMPERATURE	0°C ~ 60°C	
◆ STORAGE TEMPERATURE	-20°C ~ 80°C	
◆ LCD SCREEN		96.35 X 77.00 X 11.30 (mm)
◆ CONTROL FUNCTION		Adjust Brightness / Contrast

FEATURES

4"

1. 2 VIDEO INPUTS
2. 1 VIDEO OUTPUT
3. LEFT & RIGHT Reverse Image
4. Low Power Consumption.

10.4"

1. 1 VIDEO INPUT
2. 1 S-VIDEO INPUT
3. 1 VGA INPUT
4. 2 Audio INPUTS, 1 Audio OUTPUT
5. Low Power Consumption.

REVISION			
ISSUE ZONE	DESCRIPTION	DATE	REVISER

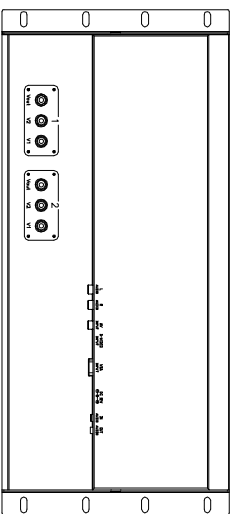
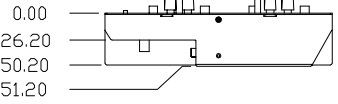
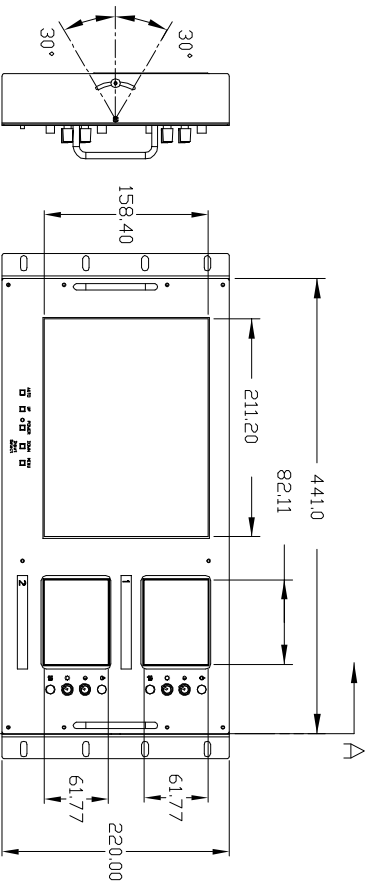
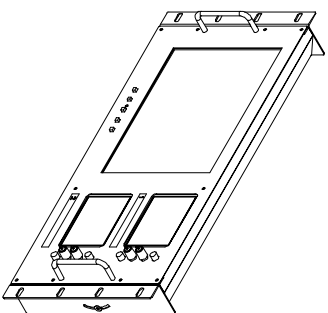
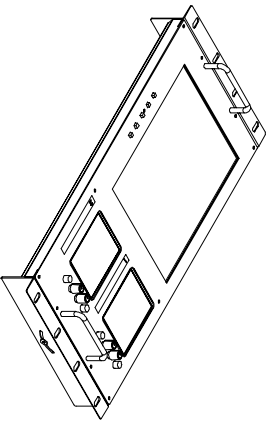
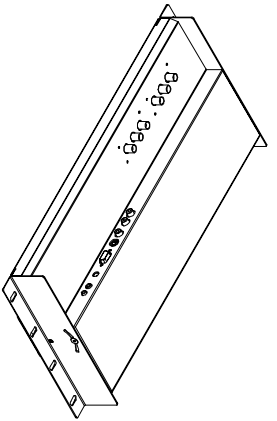

SECTION A-A

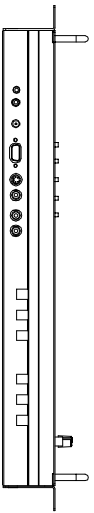

VIEWTEK [®]		MODEL NO.		PARTS NO.		MATERIAL		UNIT		PARTS NAME	
LEE MING INDUSTRIAL CO.,LTD		LRM-1012						mm		10.4"LCD + 4"LCD X 2	
DESIGN		CHECKED		APPROVED		SCALE		REV		FILE NO. DRAWING NO.	
1	2	3	4	5	6	7	8				

1 2 3 4 5 6 7 8

VGA SUPPORT MODE

Resolution	Horiz. Freq.(KHz)	Vert. Freq.(Hz)	Polarity
640X350	31.46	70	+/-
	37.86	85	+/-
720X350	31.46	70	+/-
	37.86	85	+/-
640X400	31.46	70	-/+
	37.93	85	-/+
	24.82	56	-/+
720X400	31.46	70	-/+
	37.86	85	-/+
640X480	31.46	59.9	-/-
	35.00	66.6	+/-
	37.86	72.8	-/-
	37.50	75.0	-/-
	43.27	85.0	-/-
800X600	35.15	56.2	+/+
	37.87	60.3	+/+
	48.07	72.2	+/+
	46.87	75.0	+/+
	44.40	70.0	+/+
	53.67	85.0	+/+
832X624	49.72	74.5	-/-
1024X768	48.36	60.0	-/-
	56.47	70.1	-/-
	58.08	72.9	
	60.02	75.0	+/+
	68.68	84.9	+/+
1152X864	54.90	60.0	
	64.19	70.2	+/+
	67.50	75.0	-/-
	76.30	80.0	
	77.09	84.9	
1280X1024	64.60	59.9	+/+
	63.98	60.0	-/-
	74.40	59.3	
	78.72	74.0	
	79.97	75.0	